

Detainee Policy, Procedures, and Operations

MP 3211

EDITION A

4 Credit Hours

Edition Date: April 2006

SUBCOURSE OVERVIEW

This lesson describes detainees captured or detained by the US Armed Forces and provides key definitions. These definitions explain the different personnel categories that a Military Police (MP) commander may be required to handle, protect, account for, and ensure are treated according to established laws, regulations, and international agreements. For the purpose of this lesson, the broader use of the word "detainee" applies to Enemy Prisoners of War (EPWs), Civilian Internees (CIs), Retained Persons (RPs), and other classification terms for US-controlled persons unless otherwise specified. Use of specific detainee classifications does not preclude protections granted according to Geneva Conventions I through IV (1949), Department of Defense (DoD) Directive 5100.77, or protections promulgated under paragraph 1-5 of Army Regulation (AR) 190-8. MP leaders and Soldiers conducting Internment/Resettlement (I/R) operations must maintain task proficiency for each category. For the purposes of this subcourse, detainee operations are defined as operations that take or keep selected individuals in custody as a result of military operations to control their movement and activity and/or gain intelligence.

We designed this subcourse to teach you the basic procedures in handling EPW/CIs. Contained within the subcourse is instruction on how to perform the EPW/CI mission consisting of planning, processing, movement, security, and control activities.

There are no prerequisites for this subcourse.

This subcourse reflects the doctrine which was current at the time it was prepared. In your own work situation, always refer to the latest official publication.

Unless otherwise stated, the masculine gender of singular pronouns is used to refer to both men and women.

TABLE OF CONTENTS

Subcourse Overview

LESSON 1: Detainee Operations, Command and Staff Roles and Responsibilities

Part A: Detainee Key Definitions.

- Part B: Command Roles and Responsibilities
- Part C: Military Police Roles and responsibilities.
- Part D: Critical operational planning and detainee operations.
- Part E: Responsibilities of capturing units.

Practice Exercise

LESSON 2: Detainee Movement and Facilities

- Part A: Detainee Movement
- Part B: Detainee Collecting/Holding Areas

Practice Exercise

LESSON 3: Policy and Procedures When Handling Captured Personnel

- Part A: United States policy towards detainees
- Part B: Geneva Conventions

Practice Exercise

LESSON 1

Detainee Operations, Command and Staff Roles and Responsibilities

OVERVIEW

TERMINAL LEARNING OBJECTIVE:

ACTION: Learn basic terminology and detainee operations, command and staff roles and responsibilities.

CONDITIONS: You will have this subcourse.

STANDARD: Demonstrate competency of this task by achieving a minimum passing score of 70 percent on the final subcourse examination.

REFERENCES: The material contained in this lesson was derived from the following publications: AR 3-19.1, FM 3-19.4, FM 3-19.40, FM 5-0, DoD 5100.77, FM 14-100, FM 27-10, and AR 190-8.

INTRODUCTION

On September 11, 2001 the nature of warfare changed from a historically linear and contiguous environment to a more noncontiguous battlefield. In addition, the current enemy faced by United States (US) Armed Forces does not reflect the type of threat normally encountered in combat, uniformed combatants with a structured chain of command who adhere to the laws of armed conflict. Accordingly, US Army and MP doctrine must shift from the previous linear style conflicts to reflect this new, dynamic, and swiftly changing battlefield found during this Global War on Terrorism (GWOT). Regarding detainee operations, US Armed Forces must ensure that they conduct detainee operations in a manner consistent with the seven Army values (loyalty, duty, respect, selfless service, honor, integrity, and personal courage). By upholding the Army values, Soldiers uphold American ideals and sustain goodwill among the population. In addition, they support the humane treatment and care of detainees and assist in reducing the probability of incidents involving US Armed Forces and detainees.

PART – A - Detainee Key Definitions.

1. Captured personnel are initially all classified as detainees until their legal status has been determined. AR 190-8 is a publication that provides more information regarding the classification of individuals. The terms defined in the following paragraphs encompass all captured personnel and are classified as follows:

a. Detainees. The overarching term detainee is defined as any person captured, detained, held, or otherwise under the control of DoD personnel (military, civilian, or contractor employee). It does not include personnel being held for law enforcement purposes. Detainees may also include enemy combatants, EPWs, CIs, or RPs.

b. Enemy Prisoners of War (EPWs). EPWs are persons defined in Geneva Convention III (1949) as members of enemy armed forces and members of militias or volunteer corps forming part of such armed forces. Members of other militias and members of other volunteer corps (including those of organized resistance movements) belonging to an enemy power and operating in or outside their own territory (even if the territory is occupied) provided that such militias or volunteer corps, including organized resistance movements, fulfill the following conditions:

(1) They are commanded by a person responsible for his subordinates.

(2) They have fixed distinctive signs that are recognizable at a distance.

(3) They carry arms openly.

(4) They conduct operations according to the laws and customs of war.

(5) Members of the enemy, regular armed forces who profess allegiance to a government or an authority not recognized by the detaining power (the United States).

(6) Persons who accompany the armed forces of the enemy without actually being members thereof, such as civilian members of military aircraft crews, war correspondents, supply contractors, members of labor units, or individuals responsible for the welfare of the enemy armed forces, provided that they have received authorization from the armed forces that they are accompanying.

(7) Members of crews, including masters, pilots, and apprentices of the merchant marine and the crews of civilian aircraft of the enemy, who do not benefit by more favorable treatment under any other provisions of international laws.

(8) Inhabitants of a nonoccupied territory who, on the approach of the US Armed Forces,

spontaneously take up arms to resist the invading forces without having time to form themselves into regular armed units, provided that they carry arms openly and respect the laws and customs of war.

c. Civilian Internees (CI). A civilian may be interned during an international armed conflict or belligerent occupation for imperative reasons of security as a safety measure and for protection, or he may be interned because he has committed an offense (generally a minor offense intended to harm the occupying force) subject to internment or simple imprisonment under Article 68 of Geneva Convention IV (1949). The final status of the CI may not be determined until his arrival at the Theater Internment Facility (TIF). Until such time, all CIs should be treated as EPWs. CIs are especially protected against all acts of violence, insults, public curiosity, bodily injury, reprisals of any kind, sexual attack (such as rape and forced prostitution), or any form of indecent assault or improper sexual conduct.

d. Retained Person (RP). RPs are enemy personnel who fall within any of the following categories, thus becoming eligible to be certified as RPs:

- (1) Medical personnel who are members of the medical service of their armed forces
- (2) Medical personnel exclusively engaged in—
 - (a) The search for, collection, transport, or treatment of the wounded or sick
 - (b) The prevention of disease
 - (c) The administration of medical units and establishments
- (3) Chaplains attached to enemy forces
- (4) Staff of the Red Cross or Red Crescent Societies and other voluntary aid organizations

Note: These organizations must be duly recognized and authorized by their governments. The staffs of these organizations may be employed in the same duties as mentioned above if such organizations are subject to military laws and regulations.

(5) An RP is a special category for medical personnel and chaplains because of their special skills and training. They may be retained by the detaining power (see FM 27-10) to aid detainees, preferably those of the armed forces to which the RPs belong. According to the Geneva Conventions, RPs receive, at a minimum, the benefits and protection enjoyed by EPWs. The Geneva Conventions require that they be granted the facilities necessary to provide medical care and religious ministrations to detainees. For a complete discussion on RPs, see AR 190-8. Privileges and considerations extended to RPs because of their profession include—

- (a) Additional correspondence privileges for chaplains and the senior retained medical personnel
- (b) All facilities necessary to provide detainees with medical care, spiritual assistance, and welfare services
- (c) The authority and means of transportation for periodic visits to I/R facilities and to hospitals outside the detainee's I/R facility to carry out his medical, spiritual, or welfare duties
- (d) The restriction of work assignments to only those medical or religious duties that they are qualified to perform

(e) The assignment to quarters separate from those of detainees (when practicable)

e. Enemy Combatants. The term "detainee" may also refer to enemy combatants. The term "enemy combatant" is further divided as follows:

(1) Lawful Enemy Combatants. Lawful enemy combatants include those who qualify for EPW status, as described on [page 1-7](#), paragraph (2) of this lesson, and members of regular armed forces who profess allegiance to a government or an authority not recognized by the detaining power.

(2) Unlawful Enemy Combatants. Unlawful enemy combatants are persons who are not entitled to combatant immunity, who engage in acts against the United States or its coalition partners in violation of the laws and customs of war during armed conflict. Spies and saboteurs are traditional examples of unlawful enemy combatants. For the purposes of the GWOT, the term "unlawful enemy combatant" is defined, but is not limited to an individual who is or was part of supporting Taliban or Al Qaida forces or associated forces that are engaged in hostilities against the United States or its coalition partners.

f. Dislocated Civilians (DC). DCs are civilians who leave their homes for various reasons. Their movement and physical presence can hinder military operations. They most likely require some degree of aid, such as medicine, food, shelter, or clothing. DCs may not be native to the area or to the country in which they reside. DC is a generic term that is further subdivided into five categories. These subcategories are defined by legal and political considerations as follows:

(1) Displaced Person. A displaced person is a person who has been dislocated because of war, a natural disaster, or political/economic turmoil. Consequently, the civilians' motivation to flee and their status under international and domestic laws vary as do the degree of assistance required and the location of relief operations. The political, geographical, environmental, and threat conditions also vary in each situation.

(2) Refugee. Geneva Convention (1951) states that a refugee is a person who "owing to a well-founded fear of being persecuted for reasons of race, religion, nationality, membership in a particular social group, or political opinion, is outside the country of his nationality, and is unable to or, owing to such fear, is unwilling to avail himself of the protection of that country."

(3) Evacuee. An evacuee is a civilian removed from his place of residence by military direction for reasons of personal security or other requirements of the military situation.

(4) Stateless Person. A stateless person is a civilian who has been denationalized, whose country of origin cannot be determined, or who cannot establish his right to the nationality he claims.

(5) War Victim. War victim is a classification that was created during the Vietnam era to describe civilians suffering injuries, loss of family members, or damage to or destruction of their homes because of war.

(6) Migrant. A migrant is a worker who moves from one region to another by chance, instinct, or plan.

(7) Internally Displaced Person. An internally displaced person may have been forced to flee his home for the same reason as a refugee, but he has not crossed an internationally recognized border.

(8) Expellee. A civilian outside the boundaries of the country of his nationality or ethnic origin who is being forcibly repatriated to that country or a third country for political or other purposes.

2. Persons Treated as Prisoners of War. All Soldiers must be able to understand the term "treatment" versus "status." To treat a detainee as an EPW does not mean that the detainee has the actual status of an EPW, as set

forth in the Geneva Conventions. Any time there is a question as to the actual status of a detainee, US Soldiers treat the detainee as an EPW until his status is determined. A detainee's behavior while inside a facility may be a contributing factor in determining status. The following persons are also treated as EPWs:

a. Personnel who would qualify for EPW status, as described on page 1-4, paragraph (2) of this lesson, but enter the custody of the United States as a neutral or nonbelligerent power.

b. Persons belonging to or having belonged to the armed forces of a country occupied by the United States, if the United States considers it necessary by reason of such allegiance to intern them. Particular attention is paid to those persons who have made an unsuccessful attempt to join the armed forces and are engaged in combat or have failed to comply with a summons made to them.

3. Determination of Enemy Prisoner of War Status. Captured enemy personnel may be presumed to be EPWs immediately on capture if the circumstances are unmistakable (such as an armed, uniformed enemy). If there is any doubt whether enemy personnel captured by the US Armed Forces belong to any of the categories described above, such personnel receive the same treatment to which EPWs are entitled until their status has been determined by a competent military tribunal according to AR 190-8. This tribunal is commonly referred to as an Article 5 Tribunal and originates in Geneva Convention III. This tribunal is simply a hearing typically controlled by an officer or board of officers who make a determination as to the actual status of a detainee. This tribunal can take place anywhere, but it most commonly takes place echelons above the Brigade Combat Team (BCT). In learning step 2, we will cover the Geneva Conventions, understanding that only the EPWs meet qualification under the Geneva Conventions. All others will be treated under the principles of the Geneva Conventions.

PART B - Command Roles and Responsibilities.

1. Command Responsibilities, Detainee Collection Points (DCP), Detainee Holding Areas (DHA), and internment facilities are organized and operated as military commands. Each one is operated by a US MP commissioned officer. The senior MP officer at each echelon has control over all assets operating within these areas, yet he does not establish medical and interrogation priorities. Commanders at all levels must ensure that all detainees are accounted for and treated humanely.

2. The current COE, with respect to detainee operations, demonstrates a clear necessity for a single chain of command from the point of capture to the TIF. In addition, all the people involved in detainee operations must understand their duties and responsibilities. The many facets of detainee operations, from the proper and humane treatment of detainees to the enforcement of international laws, require meticulous attention to detail. Those responsible for conducting detainee operations, from initial capture to interrogation operations, must be continually aware of the sensitivity and potential strategic implications of their actions on the national image.

3. The commander is responsible for all that his unit does or fails to do. In the area of detainee operations, he is responsible to ensure that US policy is carried out. In general, the commander must provide for the implementation of the Geneva Conventions and other treaties or agreements as well as the humane and efficient care, and full accountability for all captured persons. These responsibilities are implemented through the various staff officers and subordinate commanders. Commanders at all levels are responsible for ensuring that their personnel are familiar with the law of war and that they abide by it. The provisions of the Geneva Conventions are applicable to the handling of prisoners from the time they are captured until they are released or repatriated. When a person is captured, even in the heat of battle, he must be given the protection to which he is entitled as a detainee. When the US ratifies treaties, such as the Geneva Conventions, they become US law. Under all circumstances, prisoners are to receive humane treatment without distinction based on race, nationality, religious belief, political opinion, or other similar criteria. Detainees may not be murdered, mutilated, tortured, or degraded. They may not be punished without a previous judgment pronounced by a

legally constituted court. They are entitled to those judicial guarantees, which are recognized as indispensable to a fair trial. Staff officer responsibilities are covered in the following paragraphs.

4. Staff Officers' Responsibilities. Comparable staff officers at tactical headquarters and at Combat Service Support (CSS) commands generally have responsibility for the same functional areas of command interest inside an I/R or confinement facility. However, the emphasis on different aspects and the scope and magnitude of detainee and US military prisoner activities vary among echelons of Combat Support (CS) commands and I/R commands. This appendix describes the staff officers that may be found at different echelons of command (primarily I/R MP units) and their areas of responsibility.

a. Adjutant. The adjutant is responsible for maintaining personnel records for detainees or US military prisoners. Each I/R battalion has a personnel and administrative section, which is capable of in-processing eight personnel per hour (depending on the category). The adjutant provides accountability documents to the Internment Resettlement Information Center (IRIC) or Theatre Detention Reporting Center (TDRC) when applicable. The adjutant also maintains labor records and timecards for prisoners, submits required reports on prisoners, and prepares documents for administrative courts-martial charges for detainees or US military prisoners. The appropriate number of personnel from the modular team augments the adjutant.

b. Finance Officer. Finance personnel are responsible for the accounting of impounded financial assets (cash and other negotiable instruments) of applicable detainees (see FM 14-100). An I/R finance section is found in each I/R battalion. Finance personnel coordinate with the supporting finance unit to record pay and/or labor credits, canteen purchases and/or coupons issued, and other transactions. They coordinate payrolls, disbursements, and repatriation settlements processing. The finance section chief advises the commander on finance and accounting issues.

c. Civil-Military Operations (CMO) Officer. The CMO officer is responsible for—

(1) Providing technical advice and assistance in the areas of continuous community relations and information strategies

(2) Planning positive and continuous community relations programs to gain and maintain public understanding, good will, and support for military operations

(3) Providing liaison and coordinating with other US government agencies; host nation civil and military authorities concerned with I/R operations; and Non-Governmental Organizations (NGO), International Organizations (IO), and International Humanitarian Organizations (IHO) in the Area of Operation (AO)

(4) Coordinating with the Staff Judge Advocate (SJA) concerning advice given to commanders about Rules of Engagement (ROE) for dealing with detainees

(5) Providing technical advice and assistance in the reorientation of enemy defectors or detainees

d. Chaplain (Unit Ministry Team). The chaplain or unit ministry team assists the commander in providing religious support for I/R operations. This support is for both assigned Soldiers and detainees. The chaplain or team—

(1) Advises the commander and staff, with the G5 (S5), as well as the detainees within the facility, of the impact of the faith and practices of indigenous religious groups in an AO

(2) Provides religious support to the command and community, to include confined or hospitalized personnel

(3) Exercises supervision and control over RP religious leaders within the facility

e. Engineer Officer. The engineer officer is responsible for the repair and utilities branch, which provides and maintains the utilities (including heat, light, water, and sanitation). His section may train detainees for internal and external labor requirements that involve construction or repair of facilities. Engineer personnel who train the detainees also supervise them. The brigade engineer officer is a captain. The battalion engineer officer is a lieutenant. The engineer section provides—

(1) Construction support for the facilities

(2) Construction, maintenance, repairs, and operations of utilities, including water supply systems and portable or fixed electric power plants

(3) Fire protection measures for the facilities

(4) Insect and rodent control and fumigation of buildings in the I/R complex

f. Public Affairs Officer (PAO). The PAO is responsible for understanding and fulfilling the information needs of Soldiers, the Army community, and the public in matters relating to detainees and the facility. In the interest of national security and the protection of detainees from public curiosity, detainees will not be photographed or interviewed by news media. The PAO also—

(1) Serves as the command's spokesman for all communication with external media

(2) Facilitates media efforts to cover operations by expediting the flow of complete, accurate, and timely information

g. Signal Officer. The signal officer is responsible for all matters concerning signal operations, automation management, network management, and information security. The signal officer is located at the brigade.

h. Staff Judge Advocate (SJA). The SJA provides operational law advice and support on US military prisoner operations and resettlement operations (particularly the interpretation of the Geneva Conventions), to include the application of force in quelling riots and other disturbances. The SJA also provides advice and support in any investigation that is required following the death or injury of a detainee during internment. In addition, he serves as the recorder for Article 5 Tribunals, which determine the status of persons who have committed hostile acts but whose status is doubtful. A tribunal may be established to determine the status of an individual because of complaints and/or inquiries received from the protecting powers or the International Committee of the Red Cross (ICRC). The SJA serves as the commander's liaison to the ICRC and provides legal advice to the commander on—

(1) Military justice

(2) Administrative law (including investigations and command authority)

(3) Civil law (including contract, fiscal, and environmental laws)

(4) International laws (including the law of war, Geneva Conventions, status of forces, ROE, and treatment of detained persons)

(5) Claims

(6) Legal assistance

The SJA provides technical advice and assistance pertaining to the detainee labor policy as it relates to supporting local indigenous requirements that do not directly advance the war effort. The SJA ensures that the policy complies with all treaties and conventions. The SJA is located at the brigade. See FM 5-0 for a complete listing of duties and responsibilities.

i. Medical Personnel. Medical personnel are responsible for the Combat Health Support (CHS) of the command and the detainees within the facility. This section advises the commander and his staff, plans and directs Echelon I CHS, and arranges for Echelons II and III CHS (including air/ground medical evacuation and hospitalization) when required. It provides for the prevention of disease through the Preventive Medicine (PVNTMED) programs. It consists of—

(1) The medical treatment squad, which provides routine medical care (sick call) and advanced trauma management for duty Soldiers and detainees. US medical personnel supervise qualified RPs who are providing medical care for detainees. The squad performs initial medical exams to determine the physical fitness of arriving detainees as stipulated by the Geneva Conventions. This squad has the capability to operate as two separate treatment teams.

(2) The PVNTMED section, which provides limited PVNTMED services for the facility, performs sanitary inspections of housing, food service operations, water supplies, waste disposal operations, and other operations that may present a medical nuisance or health hazard to personnel. It provides training and guidance on all aspects of PVNTMED to the staff, unit personnel, and others involved in the operation.

j. Movement Control Officer. The movement control officer plans and coordinates movement of detainees and their property with the Corps Support Command (COSCOM) movement control center and coordinates with brigade operations for the daily transportation requirements for evacuation and transfer of detainees. This includes determining the transportation requirements for the evacuation of detainees from one level of internment to the next and coordinating the arrangements.

k. Inspector General (IG). The IG is located only at the brigade. The IG section—

(1) Advises the I/R brigade commander and staff on the organization's inspection policy

(2) Conducts inspections, surveys, and studies to comply with international, state, and US laws

(3) Receives allegations and conducts investigations and inquiries based upon reports and/or information obtained from EPWs/CIs, DCs, US military personnel, and/or multinational guard and/or police forces

(4) Consults with international and US agencies in matters pertaining to the overall health and welfare of detainees, US military prisoners, or DCs

(5) Determines the MP unit's discipline, efficiency, morale, training, and readiness and provides feedback to the chain of command

(6) Resolves complaints by detainees or US Armed Forces in a manner consistent with military necessity

(7) Identifies negative trends to correct and improve I/R operations consistent with doctrine, military laws, international laws, United Nations (UN) mandates, and foreign nation/state laws

(8) Assists in the resolution of systemic issues pertaining to the processing and administration of the protected population

The IG's office reports allegations of war crimes from either the detainees or US military prisoners (upon receipt) through the chain of command to the SJA or the United States Army Criminal Investigation Command (USACIDC). The IG does not investigate war crimes. Primary investigative responsibility for alleged war crimes belongs to USACIDC. The SJA provides the USACIDC with legal advice during war crimes investigations.

l. Psychological Operations (PSYOP) Officer. The officer in charge of the EPW/CI PSYOP team supporting I/R operations serves as the special staff officer responsible for PSYOP. The PSYOP staff officer advises the MP commander on the psychological impact of MP or Military Intelligence (MI) actions to prevent misunderstandings and disturbances by the detainees. The supporting I/R PSYOP team has two missions that reduce the need to divert MP assets to maintain security in the I/R facility. The team—

(1) Assists the MP force in controlling detainees

(2) Exposes detainees to US and allied policy.

m. PSYOP Officer. The PSYOP team also supports the MP custodial mission in the I/R facility. Their tasks include—

(1) Developing PSYOP products designed to pacify and acclimate detainees to accept US facility authority and regulations.

(2) Gaining the cooperation of detainees to reduce the need for guards.

(3) Identifying malcontents, trained agitators, and political officers within the facility who may try to organize a resistance or create disturbances.

(4) Developing and executing indoctrination programs to reduce or remove pro-enemy attitudes.

(5) Recognizing political activists.

(6) Providing loudspeaker support when necessary, such as in providing administrative announcements and facility instructions.

(7) Helping the MP commander control the detainee populace during emergencies.

(8) Planning and executing a PSYOP program that produces an understanding and appreciation of US policies and actions. PSYOP personnel use comprehensive information, reorientation, and educational and vocational programs to prepare detainees for repatriation.

n. PSYOP Officer. The PSYOP officer is an integral part of the I/R structure. The I/R facility commander may designate a location in which PSYOP personnel can conduct interviews of the various categories of people associated with I/R. This location must be separate and away from the interrogation areas.

o. Civil Affairs (CA) Personnel. CA personnel primarily support CMO. They conduct DC operations in support of I/R across the full spectrum of operations. Other related activities they conduct include—

(1) Populace and Resource Control (PRC)

- (2) Foreign internal defense
- (3) Humanitarian Assistance (HA)
- (4) Unconventional warfare

p. Intelligence Officer. The intelligence officer is responsible for advising the commander on matters pertaining to MI, operations, and training. He produces and disseminates intelligence products throughout the command.

q. Operations Officer. The operations officer is responsible for the operational planning, organizing, directing, supervising, training, coordinating, and reporting of activities when conducting confinement or detainee operations. When operating as part of an MP I/R battalion, the operations officer and his section are responsible for operating the confinement and/or detention cells for—

- (1) Detainees that are belligerent, uncooperative, or charged with Uniform Code of Military Justice (UCMJ) violations
- (2) DCs that will be turned over to civilian authorities

r. The Office of the Provost Marshal General (OPMG). The OPMG is DoD's executive agent for EPW/CI operations and long-term confinement of US military prisoners. Within the OPMG and through the combatant commander, MP personnel are tasked with coordination, protection, accountability, and sustainment for detainees and US prisoners.

s. Provost Marshal (PM). The PM advises the Commander, Detainee Operations (CDO) on MP capabilities and abilities. He coordinates daily with the commander and staff officers on the employment of MP assets and support, ensures that MP planning is practical and flexible, and ensures that plans reflect manpower and resources needed by the MP. The PM advises the CDO on the Command and Control (C2) relationship of MP and MI assets. MI Human Intelligence (HUMINT) collectors never assume command of an I/R facility. When required, the PM coordinates transportation assets to evacuate detainees. In the absence of specific directions or orders, he plans the use of assets.

t. Logistics Officer. The logistics officer is of great importance to the I/R facility commander. He is responsible for the acquisition, storage, movement, distribution, maintenance, evacuation, and disposition of materiel. He is also responsible for the movement, evacuation, and hospitalization of personnel. Additionally, the logistics officer must ensure acquisition, construction, maintenance, operation, and disposition of facilities.

PART C - Military Police Roles and responsibilities.

MP Roles and Responsibilities. The following paragraphs are designed to assist the MP process detainees for detention and internment and to collect HUMINT. Additionally, these lists outline procedures that the individual Soldier needs to be proficient in to handle and treat detainees humanely.

1. Training. Individual and collective training are the key ingredients that build and sustain Soldier confidence and unit cohesion. As much as practicable, rigorous MI and MP collective training should be conducted to replicate the detainee operations environment. Training for the receiving and processing of detainees should include, as a minimum, but not be limited to, the following:

- a. Ensuring that each detainee is treated humanely according to the provisions of the Geneva Conventions I through IV (1949), the law of armed conflict, and US policy
- b. Ensuring that each detainee is processed according to the 5 Ss and T method or STRESS
- c. Ensuring that all documents, maps, overlays, unusual equipment, or other items of potential intelligence value are secured and accounted for on detainees' DD Forms 2745 Capture Tag (Standardization Agreement [STANAG] 2044)
- d. Being observant and looking for unusual behavior by an individual or groups of individuals
- e. Conducting a search of the detainee before and after every movement from one location to another
- f. Reporting suspicious behavior or activities immediately through the chain of command
- g. Identifying any English-speaking detainees and reporting them to MI personnel when in a non-English-speaking country
- h. Being aware of the detainees' use of passive resistance and not getting frustrated or angry

2. Receiving and Processing of Detainees. Official receiving and processing begins when detainees arrive at the TIF. MI personnel should be on hand to observe the receiving and processing of detainees in order to look for any indicators that suggest a detainee may be of intelligence value and to perform an initial inspection of Captured Enemy Documents (CED) and equipment. The number of people used to perform receiving and processing tasks depends on the number of detainees and the amount of time available. Other Soldiers assigned to the unit may perform non-MP and nonmedical specific tasks if necessary.

3. Interrogating. MP personnel are generally responsible for the safe and efficient movement of detainees from their holding cell to the interrogation facility and back again after the interrogation is complete. Additionally, they provide security for HUMINT collectors during the interrogation. HUMINT collectors should ask MP to provide information from custodial observations of detainees (such as during meal times or recreation periods). The following represents what MP personnel may and may not do during interrogations. MP—

- a. May not set the conditions for interrogation practices.
- b. May not "soften up" detainees before or after an interrogation session by MI collectors.
- c. May provide incentives in support of interrogation operations under the following conditions:
 - (1) When the use of incentives is coordinated with and approved by the MP facility commander (theater and strategic)
 - (2) When the provision or withdrawal of incentives does not affect the baseline standards of humane treatment
 - (3) When the use of incentives does not violate detainee custody and control or facility security (theater and strategic)
- d. May not place detainees in any disadvantageous situation with the intention of "softening them up" for interrogation.

e. Will report (with MI personnel) any and all alleged violations of the law of armed conflict that US, coalition, or allied personnel or other persons commit.

f. Are obligated to protect such detainees against all acts of violence to include murder, rape, forced prostitution, assault, theft, public curiosity, photographing, filming/videotaping (for other than administrative purposes), bodily injury, placement of detainees in humiliating or embarrassing positions, and reprisals of any kind within a collection area, DHA, or an internment facility (theater or strategic). This requirement also applies to MI personnel.

4. The MP Commander must—

a. Ensure that detainees are treated in a humane manner throughout the process.

b. Ensure that detainees are scheduled for interrogation according to established policy and procedures.

c. Verify that the detainee's escorts are fully trained and equipped to move the detainee to and from the interrogation facility.

d. Ensure that detainees are fully searched (using same-sex personnel) before their movement to the interrogation facility and before their return to the DHA.

e. Ensure that HUMINT collectors are briefed on the behavior of the detainee in the detention area and while en route to the interrogation facility. The following are possible items of interest for briefings:

(1) Was the detainee a leader or a troublemaker?

(2) Was the detainee on a hunger strike?

(3) Did the detainee attempt to destroy his identification band or other issued property?

(4) Was the detainee agitated (for example, nervous and/or terrified) en route?

(5) Did the detainee attempt any communication with the guards or other detainees during his transport to the interrogation facility?

(6) Ensure that MP personnel are on hand and available to respond to emergencies in the interrogation facility.

f. Generally, MP personnel cannot be present in the actual interrogation room while an interrogation is underway. Interrogation facilities should be designed so that MP personnel can visually monitor interrogation sessions and respond if a detainee becomes overly aggressive or needs medical attention. This can be accomplished through the use of closed-circuit television equipment or the use of one-way, mirrored glass. Additionally, guard personnel should immediately terminate any interrogation in which US policy or other rules and regulations pertaining to the humane treatment of detainees are violated. All such violations must be reported through the appropriate channels.

g. Each HUMINT collection mission is conducted for a definite purpose. The HUMINT collector must keep this purpose firmly in mind as he seeks to obtain usable information to satisfy the requirements and contribute to the success of the unit's mission. The key to good HUMINT collection is preparation on the part of the collector. The HUMINT collector must understand the environment (particularly its human component), his source, the supported unit's mission, its intelligence requirements, and the culture.

h. Regardless of the type of operation, the initial impression that the HUMINT collector makes on the source and the approach he takes to gain the source's cooperation have a lasting impact on the continuing relationship; they also impact his success in collecting information. The approach used varies based on the type of operation; the operational environment; the status of the source; the personality, position, and identity of the source; and the personality and experience level of the HUMINT collector. HUMINT operations (to include collection, screening, source operations, interrogations, and approach techniques) are strictly governed by international laws to include the Geneva Conventions I through IV (1949), the Hague Conventions, US laws, ROE, and other operationally specific guidelines (for example, DOD policy). All leaders are responsible for ensuring that HUMINT operations comply with these governing regulations and guidelines. MP personnel involved in monitoring detainee interrogations must familiarize themselves with the above-mentioned laws and applicable policies and directives so that they can report any violations to the chain of command.

i. HUMINT collectors must immediately relay to MP personnel any information obtained during an interrogation that pertains to the physical security of the facility or that is of value from a force protection standpoint. This includes information such as planned disturbances, escape attempts, and the use of passive resistance. The local Standard Operating Procedure (SOP) should establish a formal means of relaying such information to the MP chain of command, in addition to normal MI reporting channels.

5. Transferring between facilities. A transfer may be the result of reclassification or another situation requiring the movement of a detainee from one theater's facility to another. The conditions of the transfer are comparable to those of a member of the US Armed Forces, when possible. Security measures are determined by MP and are influenced by the type of detainee being transferred, the mode of transportation used, and other pertinent conditions. The Detention Facility Commander (DFC) (theater and strategic) has overall responsibility for the safe transfer of detainees from his facility.

6. Transferring to Host Nation (HN) or Allied Facilities and Inter-service Agencies. The permanent transfer of a detainee from the custody of US forces to the HN or other allied forces requires the approval of the Secretary of Defense. The permanent transfer of a detainee to HN control is governed by bilateral national agreements. A detainee can only be transferred from US custody to a power that is a party to the Geneva Conventions. A US representative visits the power's internment facilities and ensures that the power is willing and able to comply with the Geneva Conventions. The temporary transfer of detainees is authorized to accommodate surges in the detainee population that are beyond US capacity. The Theatre of Operations (TO) commander develops measures to ensure accountability and the humane treatment of detainees who are temporarily transferred. A detainee who is captured or detained by the US Marine Corps, Navy, Air Force, or Coast Guard is turned over to the US Army at receiving points designated by the TO commander. Inter-service transfers are affected as soon as possible following initial classification and administrative processing.

7. Releasing Detainees. Release is the process of returning a detainee to his country of birth or citizenship. A detainee who is not sick or wounded is released at the end of hostilities as directed by the Office of the Secretary of Defense (OSD). The key to a successful release process is control and accountability.

8. Transferring Civilian Internees (CIs). CIs cannot be transferred outside the borders of the occupied country where they are interned. They will be transferred if they will be exposed to greater risk by remaining at the facility if the Combat Zone (CZ) moves closer to the location.

Note: CIs who are sick, wounded, infirmed, or pregnant are not transferred if it would be detrimental to their health. A CI can be released to a representative of his country of residence or a designated protecting power if control and accountability are maintained. He can be released after hostilities cease (subject to pending judicial proceedings) if the reasons for his internment no longer exist as determined by the TO commander. A CI who is eligible for release but has judicial proceedings pending for offenses not exclusively subject to disciplinary

punishment is detained until the close of proceedings. The TO commander may decide that a CI must serve his penalty before being released; a CI already serving a penalty may be similarly detained. Rosters of detained CIs are forwarded to the TDRC and the National Detainee Reporting Center (NDRC) for transmittal to the protecting powers.

PART D - Critical operational planning and detainee operations.

1. US policy stipulates and directs that all persons who are captured, retained or held by US Armed Forces during a conflict be treated humanely. This policy applies from the moment detainees are captured until they are released, repatriated, or transferred. The following are critical operational planning considerations for the point of capture and detainee operations:

- a. Ensure that operations are consistent with Army values and US policy.
- b. Expedite detainee evacuation according to military necessity.
- c. Preserve, document, and control evidence and items that may be of intelligence value.
- d. Support tactical questioning and interrogation requirements.
- e. Deescalate events at the point of capture.
- f. Ensure that Soldiers are trained and rehearsed on the use of ROE and rules for the use of force.
- g. Prevent attempts to escape, disrupt operations, or harm US Armed Forces.
- h. Provide adequate resources.

2. When planning tactical-level operations that may include capturing detainees, remember to plan for detainee processing regardless of the mission. Consider the following:

- a. Use the latest intelligence for capture estimates.
- b. Use detainee field-processing kits to process detainees at the point of capture.
- c. Prepare to establish a hasty Initial Detainee Collection Point (IDCP) as close to actual operations as possible.
- d. Plan security to provide force protection against external threats.
- e. Plan for transportation and resource requirements.
- f. Brief the Soldiers on the detainee mission. Consider the following information for the briefing:
 - (1) Establishing search, security (force protection), and escort teams.
 - (2) Ensuring that the search team members (designated search personnel, guards, and interpreters) clearly understand their roles and responsibilities.

(3) Reviewing the ROE and rules for the use of force and reinforcing the treatment of detainees according to military policy.

(4) Brief the Soldiers on how to reach a decision to detain. Have them consider, but not limit themselves to the following questions:

(a) Does the detainee show hostility toward detention personnel?

(b) Did the detainee have weapons on him when he was captured?

(c) Did the detainee drop the weapons and attempt to escape?

(d) What was the detainee doing upon capture?

(e) Are there physical differences in appearance between the detainee and other detainees captured (for example, is he wearing shoes and others are not)?

(f) What is the condition of the detainee's equipment?

(g) Does the detainee have teeth in better condition than the other detainees?

(h) Is the detainee clothed differently?

(i) Is there a language difference between those in the group (that reflects educational or regional differences within the group)?

(j) Were multiple identification documents found on the detainee?

(k) Were large sums of cash found on the detainee, in his home, or in his vehicle?

(l) How do other members of the group react toward the detainee?

(m) Has a detainee receiving special attention from other group members been in the village or town very long?

(5) Rehearse detainee operations, from capture to transfer or release. Consider having Soldiers rehearse—

(a) Capture, search, security, and escort functions.

(b) The ROE and rules for the use of force.

(c) Scenarios that will build Soldiers' skills and confidence.

3. The point of capture is the first point at which a decision is made to either retain or release a detainee. Leaders at the point of capture must review the circumstances of capture, confiscated items, and intelligence and evidentiary value to provide a thorough assessment. Accordingly, sufficient information should be reported up through the chain of command for them to make an informed decision on whether to retain or release the individual.

PART E - Responsibilities of capturing units.

1. MP personnel perform collection, evacuation, and internment operations to receive, safeguard, and intern detainees. Detainees are received from capturing troops. Capturing troops may well be other MP. They may also be units of the United States Air Force (USAF) and the United States Navy (USN). All MP must be prepared to receive detainees. This includes MP in rear areas performing missions having little to do with detainee operations.

2. Detainees captured in the main battle area are handled using the five Ss and T.

a. Search. They will do a preliminary search of the detainees. We, as MP, need to remember that they are probably not well trained on this task and we will always conduct another search when we take custody. Search captives for weapons and ammo, items of intelligence, value, and other inappropriate items.

b. Safeguard. While they are responsible to safeguard the detainees, it is often hard for combat arms Soldiers, who may have been in direct combat with these detainees just minutes prior, to control their anger. It is extremely important for us, as MP, to thoroughly document the physical condition of detainees upon taking custody, to protect our Soldiers from being blamed for injuries that may have occurred previously. Safeguard according to Geneva Conventions and US Policy. Provide medical care as needed.

c. Silence. Capturing units will take all necessary measures to ensure the silence of detainees, to include gagging. Do not allow them to speak or anyone to speak to them except to give them orders.

d. Speed. Rapid evacuation gets prisoners away from the main battle area to safety. This is a requirement of international law.

e. Segregate. While capturing units are supposed to segregate prisoners, they may not have done a good job. Never assume that the capturing unit properly segregated them. Segregate by rank, gender, nationality, and status.

f. Tag. When the detainees arrive at your location, they should already be tagged. However, that is usually not the case. It is important that you get all pertinent information, such as place of capture and capturing unit, from the unit that you receive them from. This allows you to properly tag them. Use DD Form 2745 or a field expedient capture tag that states date of capture, location of capture (grid coordinate), capturing unit and any special circumstances of capture. After doing this, evacuate to the nearest division collection point.

3. Once captured personnel have been tagged and transported to the nearest collection point, they are turned over to the MP for further processing. The acronym STRESS is used to ensure the safety and protection of both the detainees and the MP.

a. Search. Even though the capturing troops have already searched the prisoners, they should be searched again. This will be a more detailed search than that normally done by the capturing troops. The search is for concealed weapons, as well as for items of intelligence value. Prisoners are allowed to keep personal items of no military value. Any protective gear that is taken, such as helmets or protective masks, must be replaced.

b. Tag. All captives should be tagged by the capturing unit before they arrive at the collection point. If they have not been tagged, a tag will be prepared by gathering info from the capturing unit. The tag must be filled out as accurately as possible. It must also be noted that the prisoner arrived at the collection point without a tag.

c. Report. The MP in charge makes a detainee status report through his chain of command. Reports must be sent through two channels (see figure 1-2). The first report must go to the PM. This notification provides

the PM the overall picture of detainees' operations within his area of responsibility. Additionally, the notification will energize the evacuation process. The second report goes through the unit support channels. This allows for the appropriate staff officer to provide any required resources such as rations and water. Additionally, the report aids in transportation and the security planning process.

d. Evacuate. Detainees should be evacuated from the collecting points as soon as possible. The squad leader coordinates with his platoon leader for their removal. The platoon leader requests guards and transportation from the company commander. The company commander obtains support through the PM operations section. Nondivisional MP that have received custody of detainees should contact the nearest MP unit handling detainees, through their chain of command.

e. Segregate. Segregation of detainees is crucial to maintaining control and security. Enemy officers or NCOs may try to influence other prisoners to resist or try to escape. If the capturing troops did not segregate the prisoners, MP personnel should do it. If some segregation has been accomplished, MP personnel may be able to further segregate prisoners. Segregation at the collecting point is done using field expedient material. At forward collecting points, this may be no more than marking different areas with engineer tape. Concertina wire may also be used. The prisoners are segregated so that categories cannot communicate, either by voice or visually. Detainees should be segregated as possible by the following categories:

- (1) Grade
- (2) Status (Detainees/CI/RP/Enemy combatant)
- (3) Sex
- (4) Religion
- (5) Nationality
- (6) Political Leanings

f. Safeguard. Detainees must be safeguarded from US Soldiers who might want to do harm to them. Detainees must also be safeguarded from other enemy Soldiers who might do harm to them. Detainees must be guarded, given medical care, and provided basic sanitation. MP personnel are not required to provide CBRN protective equipment to detainees that arrive at the collecting point without it. If a CBRN environment is expected or encountered, every effort should be made to leave or avoid the contaminated area. If extra equipment is on hand, it should be used to protect the prisoners as best they can. When available, maximum use of captured enemy equipment, of no intelligence value, should be made.

NOTE: MP must conduct a thorough search of the detainees. Always keep in mind, that the capturing unit may have missed something. If possible, always have males search males and females search females. The wall, prone, and strip are the three types of searches used.

4. Everything the detainee has is examined. During your search, you discover items and property on the detainee. A DA Form 4137, Evidence/Property Custody Document is prepared for all property that is taken from the detainee and is evacuated concurrently with the detainee. Property that is of intelligence value is released to the Interrogation of Prisoner-of-War (IPW) section and evacuated through MI channels. The chain of custody is maintained by the DA Form throughout the evacuation process. Property can be classified into 3 categories.

a. Confiscated. Part C of the EPW tag is attached to confiscated property not retained as the tag states. During Desert Storm, confiscated property was put in sand bags. This caused the problem of passing property back through the evacuation process. At some point, confiscated property will be destroyed. This should be authorized by the senior MP commander. Examples of confiscated property include items with intelligence value (maps and orders), weapons, ammunition, and other inappropriate items.

b. Impounded. A captive is not allowed to keep impounded items during his internment. These items can make escape easier or can compromise US security interests. These are personal items of value, which will be eventually returned to the detainee. The items must be inventoried and signed for to maintain a chain of custody. Examples are cameras, radios, currency, and negotiable instruments.

c. Retained property. A captive is allowed to keep certain items during captivity. These items are generally divided into two groups. The first group consists of items taken during the receiving portion of in-processing and returned later in the process. The second group consists of items that the captive can keep at all times.

(1) Group 1.

(a) Military mess equipment (except knives and forks)

(b) Helmet

(c) Protective clothing and equipment (CBRN suits, helmets, and protective masks) for use during evacuation from the CZ

(d) Personal clothing

(e) Badges of rank and nationality

(f) Military decorations

(g) ID cards and tags

(h) Rations (in the early stages of captivity)

(2) Group 2.

(a) Religious literature (within reason)

(b) Personal items having no intelligence value (jewelry and pictures)

Note: The Geneva Convention requires that we keep accountability for all detainees. Initially, we account for them by EPW tag/name. This data is forwarded with the detainees when they are evacuated to the next facility. At some point (typically the Corps Holding Area) the detainees are issued an Internment Serial Number (ISN) that will identify them for the remainder of their time in custody. Remember, accountability starts with the capture tag.

Report as of: DTG. Last Report: DTG detainees medical channels. ALPHA-Reporting unit (call sign).	FOXTROT-Number of evacuated in
evacuated in MI channels. BRAVO-Location of detainee collecting point.	GOLF-Number of detainees
CHARLIE-Number of detainees on hand.	HOTEL-Number of officers.
DELTA-Number of detainees received during report period.	INDIA-Number of NCOs.
ECHO-Number of detainees evacuated in MP internees. channels.	JULIET-Number of enlisted. KILO-Number of civilian

Figure 1-2. Enemy Prisoner of War Report

5. Capture Tags (see figure 1-3). The circumstance under which an individual is captured is important information. It will often be the most valid basis for determining status. Only the capturing troops have such knowledge. It is also critical intelligence information. This is particularly true of those detainees placed in medical channels or transported by helicopter, since they may end up far from the point of capture. It is important that the capturing troops complete a capture tag. The capture tag should include the following, as a minimum:

- a. Date and time of capture
- b. Place of capture (grid coordinates)
- c. Capturing unit
- d. Circumstances of capture (How was he captured?)

<p align="center">ENEMY PRISONER OF WAR (EPW) CAPTURE TAG (PART A)</p> <p align="center">For use of this form, see AR 190-8. The proponent agency is DCSOPS.</p> <p>Attach this part of tag to EPW. (Do not remove from EPW.)</p> <ol style="list-style-type: none"> Search - For weapons, military documents, or special equipment. Silence - Prohibit talking among EPWs for ease of control. Segregate - By rank, sex, and nationality. Safeguard - To prevent harm or escape. Speed - Evacuate from the combat zone. Tag - Prisoners and documents or special equipment. <p>DD FORM 2746 (BACK), MAY 98</p>		<table border="1"> <tr> <td>1. DATE AND TIME OF CAPTURE 1113D</td> <td>2. SERIAL NO. 0090829</td> <td align="right">A</td> </tr> <tr> <td>3. NAME DD</td> <td>4. DATE OF BIRTH 12D5</td> <td></td> </tr> <tr> <td>5. RANK D</td> <td>6. SERVICE NO. 123-45-6789</td> <td></td> </tr> <tr> <td>7. UNIT OF EPW 122D</td> <td>8. CAPTURING UNIT 4DD</td> <td></td> </tr> <tr> <td colspan="3">9. LOCATION OF CAPTURE (Grid coordinates) D82456</td> </tr> <tr> <td>10. CIRCUMSTANCES OF CAPTURE D</td> <td>11. PHYSICAL CON- DITON OF EPW D</td> <td>12. WEAPONS, EQUIP- MENT, DOCUMENTS B7D</td> </tr> </table> <p>DD FORM 2746, MAY 98</p> <p align="right">REPLACES DA FORM 5976, JAN 91, USABLE UNTIL EXHAUSTED.</p>		1. DATE AND TIME OF CAPTURE 1113D	2. SERIAL NO. 0090829	A	3. NAME DD	4. DATE OF BIRTH 12D5		5. RANK D	6. SERVICE NO. 123-45-6789		7. UNIT OF EPW 122D	8. CAPTURING UNIT 4DD		9. LOCATION OF CAPTURE (Grid coordinates) D82456			10. CIRCUMSTANCES OF CAPTURE D	11. PHYSICAL CON- DITON OF EPW D	12. WEAPONS, EQUIP- MENT, DOCUMENTS B7D
1. DATE AND TIME OF CAPTURE 1113D	2. SERIAL NO. 0090829	A																			
3. NAME DD	4. DATE OF BIRTH 12D5																				
5. RANK D	6. SERVICE NO. 123-45-6789																				
7. UNIT OF EPW 122D	8. CAPTURING UNIT 4DD																				
9. LOCATION OF CAPTURE (Grid coordinates) D82456																					
10. CIRCUMSTANCES OF CAPTURE D	11. PHYSICAL CON- DITON OF EPW D	12. WEAPONS, EQUIP- MENT, DOCUMENTS B7D																			
<p align="center">UNIT RECORD CARD (PART B)</p> <p align="center">Forward to Unit. <i>(Capturing unit retains for records.)</i></p> <p align="center">Use string, wire, or other durable material to attach the appropriate section of this form to the EPW's equipment or property.</p> <p>DD FORM 2746 (BACK), MAY 98</p>		<table border="1"> <tr> <td>1. DATE AND TIME OF CAPTURE 1113D</td> <td>2. SERIAL NO. 0090829</td> <td align="right">B</td> </tr> <tr> <td>3. NAME DD</td> <td>4. DATE OF BIRTH 12D5</td> <td></td> </tr> <tr> <td>5. RANK D</td> <td>6. SERVICE NO. 123-45-6789</td> <td></td> </tr> <tr> <td>7. UNIT OF EPW 122D</td> <td>8. CAPTURING UNIT 4DD</td> <td></td> </tr> <tr> <td colspan="3">9. LOCATION OF CAPTURE (Grid coordinates) D82456</td> </tr> <tr> <td>10. CIRCUMSTANCES OF CAPTURE D</td> <td>11. PHYSICAL CON- DITON OF EPW D</td> <td>12. WEAPONS, EQUIP- MENT, DOCUMENTS B7D</td> </tr> </table> <p>DD FORM 2746, MAY 98</p> <p align="right">REPLACES DA FORM 5976, JAN 91, USABLE UNTIL EXHAUSTED.</p>		1. DATE AND TIME OF CAPTURE 1113D	2. SERIAL NO. 0090829	B	3. NAME DD	4. DATE OF BIRTH 12D5		5. RANK D	6. SERVICE NO. 123-45-6789		7. UNIT OF EPW 122D	8. CAPTURING UNIT 4DD		9. LOCATION OF CAPTURE (Grid coordinates) D82456			10. CIRCUMSTANCES OF CAPTURE D	11. PHYSICAL CON- DITON OF EPW D	12. WEAPONS, EQUIP- MENT, DOCUMENTS B7D
1. DATE AND TIME OF CAPTURE 1113D	2. SERIAL NO. 0090829	B																			
3. NAME DD	4. DATE OF BIRTH 12D5																				
5. RANK D	6. SERVICE NO. 123-45-6789																				
7. UNIT OF EPW 122D	8. CAPTURING UNIT 4DD																				
9. LOCATION OF CAPTURE (Grid coordinates) D82456																					
10. CIRCUMSTANCES OF CAPTURE D	11. PHYSICAL CON- DITON OF EPW D	12. WEAPONS, EQUIP- MENT, DOCUMENTS B7D																			
<p align="center">DOCUMENT/SPECIAL EQUIPMENT WEAPONS CARD (PART C)</p> <p>Attach this part of tag to property taken. (Do not remove from property.)</p> <p>As a minimum, the tag must include the following information:</p> <p>Item 1. Date and time of capture (YYYYMMDD). Item 8. Capturing unit. Item 9. Place of capture (grid coordinates). Item 10. Circumstances of capture (how the EPW was captured).</p> <p>DD FORM 2746 (BACK), MAY 98</p>		<table border="1"> <tr> <td>1. DATE AND TIME OF CAPTURE 1113D</td> <td>2. SERIAL NO. 0090829</td> <td align="right">C</td> </tr> <tr> <td>3. NAME DD</td> <td>4. DATE OF BIRTH 12D5</td> <td></td> </tr> <tr> <td>5. RANK D</td> <td>6. SERVICE NO. 123-45-6789</td> <td></td> </tr> <tr> <td>7. UNIT OF EPW 122D</td> <td>8. CAPTURING UNIT 4DD</td> <td></td> </tr> <tr> <td colspan="3">9. LOCATION OF CAPTURE (Grid coordinates) D82456</td> </tr> <tr> <td colspan="3">10. DESCRIPTION OF WEAPONS, SPECIAL EQUIPMENT, DOCUMENTS B7D</td> </tr> </table> <p>DD FORM 2746, MAY 98</p> <p align="right">REPLACES DA FORM 5976, JAN 91, USABLE UNTIL EXHAUSTED.</p>		1. DATE AND TIME OF CAPTURE 1113D	2. SERIAL NO. 0090829	C	3. NAME DD	4. DATE OF BIRTH 12D5		5. RANK D	6. SERVICE NO. 123-45-6789		7. UNIT OF EPW 122D	8. CAPTURING UNIT 4DD		9. LOCATION OF CAPTURE (Grid coordinates) D82456			10. DESCRIPTION OF WEAPONS, SPECIAL EQUIPMENT, DOCUMENTS B7D		
1. DATE AND TIME OF CAPTURE 1113D	2. SERIAL NO. 0090829	C																			
3. NAME DD	4. DATE OF BIRTH 12D5																				
5. RANK D	6. SERVICE NO. 123-45-6789																				
7. UNIT OF EPW 122D	8. CAPTURING UNIT 4DD																				
9. LOCATION OF CAPTURE (Grid coordinates) D82456																					
10. DESCRIPTION OF WEAPONS, SPECIAL EQUIPMENT, DOCUMENTS B7D																					

Figure 1-3. Capture Tag

6. Capturing troops are also required to tag equipment, documents, and other items taken from the detainees. This helps link the items with the prisoner at a later date. Standard capture tags specified in STANAG 2044 are used by US forces in the North Atlantic Treaty Organization (NATO). The tag should be perforated in three parts. It should be of a durable material. Part A of the NATO standard capture tag is attached to the prisoner. Part C is attached to items taken from the prisoner. Part B, when used, is retained by the capturing unit according to SOP. STANAG 2044 requires use of Part A and Part C of the standard capture tag. Using Part B is optional. When "issue" tags are not available, troops should obtain or manufacture their own field expedient. The most important thing is to convey the information.

SUMMARY

During this period of instruction we have discussed EPW operations to include the collection and responsibilities inherent at each level of the chain of command. We have discussed MP responsibilities to ensure proper and humane treatment.

It is imperative that all MP personnel be proficient in EPW operations. EPW operations are governed by international law, thus strictly binding us to strict limits of variance. As a platoon leader, remember, "A platoon does well, what the platoon leader checks."

Lesson 1 PE

This practice exercise will show you how much you have learned in this lesson. Select the correct answer to each question. When you are done, turn the page to check your answers.

The overarching term that defines any person captured, detained, held, or otherwise under the control of DoD personnel (military, civilian, or contractor employee).

- EPW.
- Enemy Combatant.
- Detainee.
- Retained Person.

You are unsure of the category of a prisoner brought to the collecting point. Until a determination is made, you treat him as a/an

- IC.
- EPW.
- CI.
- Retained person.

In discussing the EPW planning process with your team leaders, one of them asks who is responsible for developing the EPW plan. You tell him it is the

- Adjutant.
- Intelligence officer.
- Movement control officer.
- Operations officer.
- PM.

In searching the EPW, a MP has found a military map. You know that this is what type of property?

- Retained.
- Contraband.
- Confiscated.
- Impounded.

A group of four prisoners has been brought to your collecting point by capturing troops. Only three of them have capture tags. What action do you take?

- A tag must be filled out as accurately as possible. It must also be noted that the prisoner arrived at the collection point without a tag.
- Accept the three with capture tags and return the fourth one.
- Accept all four, but submit a report through the chain of command.
- Copy the information from the other capture tags.

The circumstance under which an individual is captured is important information. The capture tag should include the following, as a minimum:

- Date and time of capture.
- Place of capture (grid coordinates).

Capturing unit.
Circumstances of capture (How was he captured?).
All of the above.

Lesson 1 ANSWER KEY AND FEEDBACK

<u>ITEM</u>		<u>CORRECT ANSWER AND FEEDBACK.</u>
-------------	--	-------------------------------------

1.	c.	Detainee.
----	----	-----------

The overarching term detainee is defined as any person captured, detained, held, or otherwise under the control of DoD personnel (military, civilian, or contractor employee) (page 1-1).

2.	b.	EPW.
----	----	------

Captured personnel are initially all classified as detainees until their legal status has been determined. AR 190-8 is a publication that provides more information regarding the classification of individuals. (page 1-1).

3.	d.	Operations officer.
----	----	---------------------

The operations officer is responsible for the operational planning, organizing, directing, supervising, training, coordinating, and reporting of activities when conducting confinement or detainee operations (page 1-13).

4.	c.	Confiscated.
----	----	--------------

Examples of confiscated property include items with intelligence value (maps and orders), weapons, ammunition, and other inappropriate items (page 1-21).

5.	a.	Obtain all pertinent information and generate a capture tag.
----	----	--

All captives should be tagged by the capturing unit before they arrive at the collection point. If they have not been tagged, a tag will be prepared by gathering info from the capturing unit. The tag must be filled out as accurately as possible. It must also be noted that the prisoner arrived at the collection point without a tag (page 1-20).

6.	e.	All of the above.
----	----	-------------------

It is important that the capturing troops complete a capture tag. The capture tag should include the following, as a minimum, date and time of capture, place of capture (grid coordinates), capturing unit, circumstances of capture (How was he captured?) (page 1-22).

LESSON 2

Detainee Movement and Facilities

OVERVIEW

LESSON DESCRIPTION:

In this lesson you will learn to plan and direct the movement of EPW/CI.

TERMINAL LEARNING OBJECTIVE:

ACTION: Learn basic operational procedures in evacuating detainees.

CONDITIONS: You will have this subcourse.

STANDARD: Demonstrate competency of this task by achieving a minimum passing score of 70 percent on the final subcourse examination.

REFERENCES: The material contained in this lesson was derived from the following publications: FM 3-19.1, FM 3-19.4, FM 3-19.40, FM 5.0 and AR 190-8.

INTRODUCTION

Military police are responsible for the collection and evacuation of detainees for US forces. The bulk of the prisoners will be captured in the main battle area by Army combat forces. They may also be captured in other parts of the Theater Army or in the Communication Zone (COMMZ). Prisoners may be taken by elements of the Air Force or Navy. The manner in which they are collected and evacuated remains the same regardless of where or which service captures them.

Capturing troops will turn detainees over to the nearest MP unit. MP in the corps and Theater Army Areas may accept custody of detainees captured by other US Soldiers. All MP personnel must be familiar with the proper handling of EPWs/CI. MP throughout the theater, regardless of their primary mission, may be tasked to assist in the evacuation of detainees.

PART A - Detainee movement.

1. General evacuation. The major principle in the evacuation flow of detainees is that the higher echelons normally go forward to pick up prisoners from lower echelons. Steps in the flow may be skipped. In other words, COMMZ MP have the capability to come forward to the division to pick up prisoners, there is no requirement for them to stop at the Corps Holding Area (CHA). This type of action is only done through close coordination with all echelons involved. Several factors are involved in evacuating EPWS this way; notably, it saves on MP manpower in the CZ and maximizes use of available transportation.
2. Before movement, an interpreter should be used to brief detainees on actions upon hearing the word "halt," the need to remain silent at all times, actions to take during an emergency (such as a delay, crash, or enemy attack), signals used to direct detainee movement, and responses to escape attempts according to the ROE and rules for the use of force. During transport, detainees should NOT be daisy-chained, unless military necessity requires otherwise. In addition, avoid restraining detainees to fixed structures or objects while in transport. Use of blindfolds is recommended to provide operational security. Maintain segregation as much as possible during movement.
3. It is very important that detainees be evacuated as quickly as possible from the CZ. Such movement should be minimized. This lessens possible interference with friendly operations. The less prisoners are moved, the fewer opportunities they have to escape. It also reduces the possibility of the prisoners falling victim to combat operations. Evacuation of prisoners makes maximum use of secondary routes to prevent interference with friendly operations.

4. Responsibility for the custody and evacuation of detainees is normally accepted by MP at the brigade level. Physically able military personnel may be used as guards to assist MP. These personnel must be properly instructed on their duties. Such a situation is unusual, but may occur when unusually large numbers of prisoners are captured.

a. Medical Evacuation Channels. Medical personnel determine if detainees must be medically evacuated. Sick and wounded detainees that are not medically evacuated are treated and returned for evacuation in MP channels. This decision is based on the prisoner's medical condition and may occur at any point along the evacuation flow. Detainee patients remain segregated from US and allied patients. The guards for prisoners in medical channels are other than medical or medical service personnel. If not MP, they must be instructed on their duties. A mix of MP and non-MP may also be used. Provision of guards for prisoners in medical channels will be prescribed by the Detainee plan or SOP of the appropriate command. Regardless of who the guards are, the procedures followed in handling prisoners in medical channels are the same as for other prisoners. The only variation is that due consideration must be made for their injuries or illness. In other words, the principles of STRESS still apply as do requirements for property receipts. Accountability for the prisoner and his property must be maintained at all times.

b. Evacuation Principles. In particular, the size of the corps, the number of detainees requiring evacuation, and the availability of transportation will have to be considered. Should conditions warrant, detainees could be evacuated from the COMMZ to the United States. Internment in the United States is similar to that in the COMMZ. Such internment in the United States was done in World War II. Fort McClellan, for example, was the location of one of the facilities.

(1) The escorting of prisoners is normally from the rear to the forward areas. In other words, the more rearward echelon goes forward to escort the prisoners; for example, corps MP escort prisoners from the division; COMMZ MP escort prisoners from the corps.

(2) In addition to humane treatment, other principles to be considered in the evacuation of prisoners are as follows:

(a) Prompt evacuation to the rear.

(b) Noninterference with tactical movement of US and allied troops.

(c) Maximum use of returning transportation of all types.

(d) Maximum and timely assistance from higher echelons.

(e) When circumstances permit, direct evacuation from any area in the CZ to a camp in the COMMZ.

(f) Evacuation of sick and wounded through medical channels.

(g) Detainees retain possession of personal items until arrival at the COMMZ facility. The exceptions to this are equipment and documents of intelligence value, and those items that must be seized for security reasons (e.g., knives and forks). Currency cannot be taken from EPWS by capturing troops unless ordered by a commissioned officer. Detainees are provided a receipt for seized property.

(h) Silence and minimum essential movement among prisoners are always maintained. This reduces collusion among the prisoners. It also prevents the spreading of false rumors that may cause them to panic.

c. Evacuation Channels. Evacuation of detainees from the CZ should be done as quickly as possible. While in the CZ, detainees may become casualties as the result of enemy fire. The modern battlefield is highly fluid. Units will be widely dispersed and facilities will be austere. The likelihood of prisoners being freed is therefore increased. The fewer there are in the CZ, the less likely they are to interfere with allied operations.

d. Evacuation Procedures.

The following procedures apply to all modes of transportation:

(1) Close liaison is maintained with the next higher headquarters. They must be informed of the location of collecting points, other detainee facilities, and the number of prisoners to be evacuated.

(2) When necessary, stops are made during daylight hours. They should be made away from towns, cities, and installations. There is a requirement to avoid public curiosity. This also facilitates the safeguarding of prisoners and lessens the possibility of their being assisted to escape.

(3) Secondary roads should be used, when possible, to avoid interference with other operations.

(4) Sufficient rations must be provided for the prisoners. Captured enemy rations should be used as much as possible. Such rations must be checked to ensure they have not become contaminated. Other enemy supplies and material may also be used for the support of the movement.

(5) Guards should communicate with the prisoners only to issue instructions. Only the minimum essential conversation between guards and prisoners should be permitted. Instructions to the prisoners should be in a language that they understand.

(6) Punishment for the violation of rules, orders, or regulations is not administered by guards.

(7) The rules of minimum force always apply.

(8) The number of escort guards required for a movement will depend on the situation. Factors that must be considered are the morale, physical condition, and number of prisoners involved. Other factors include the mode of transportation, terrain, and probability of enemy attack.

(9) Guards must be organized and equipped according to the type of transportation that is to be used.

5. Evacuation Planning.

a. The detainee plan will normally contain evacuation procedures. Those not included in the plan will be in the appropriate SOP. A major concern is to evacuate prisoners from the CZ as quickly as possible. Normally, prisoners will not be held in the division longer than 24 hours.

b. The MP unit in charge of the collecting point (or holding area) tasks the platoon leader to arrange for the evacuation of detainees. The platoon leader arranges for rations and transportation in accordance with the detainee plan and SOP.

c. The MP company commander receives a tasking from the PM or battalion commander for the evacuation of detainees. He arranges for the guards to evacuate the detainees. This is the MP unit assigned the evacuation mission; for example, a corps MP unit is tasked to evacuate prisoners from the division. The size of the guard detail depends on the situation.

d. The platoon leader decides how many MP are needed to evacuate the prisoners. He usually gives the mission to a squad leader. Each situation requires planning and judgment to determine the number of guards required. It also requires very close coordination between the two MP elements involved in the move. Soldiers returning to the rear may be tasked to assist in the evacuation of prisoners.

e. When the squad leader receives the mission, he begins his troop leading steps. He issues a warning order to his team leaders. Escort personnel are designated. Before they depart on the mission, they must be fully briefed and inspected. Plans for actions to be taken in emergency situations are fully covered. When time permits, such actions should be rehearsed. Units habitually involved in escort missions should train in contingencies at every possible opportunity.

f. The squad leader conducts a reconnaissance of the route to be followed, whenever possible. When this is not possible, a map reconnaissance is conducted, as a minimum. Of particular concern during the reconnaissance are possible hazard areas, to include ambush sites. The squad leader also should locate rest and halt locations along the route. The terrain along the route will affect the rate of march. It also will affect the number of guards required. Dense woods, jungle, and urban areas require more guards than open areas. The three major areas of concern are the location of friendly units, food and water, and the type of terrain to be traveled.

g. The location of friendly units that can provide emergency assistance is also noted. When possible, the squad leader coordinates with these units for their assistance ahead of time. Of particular concern is arranging for fire support and medical assistance. Close coordination with MP units on or near the route is also a requirement.

h. Since detainee evacuation will use secondary routes as much as possible, traffic control will be an important concern. The escort must be prepared to conduct limited traffic control. Assistance may be required from MP units along the route. MP units along the route can also provide a great deal of information about the route. They also may be able to provide back-up support, should it be required.

i. The squad leader uses a reverse planning sequence to make sure his squad is prepared for the mission. He starts from the pickup time and location and works backward. The location of the collecting point must be verified. The further forward the collecting point is, the more likely it is to move. The number of prisoners to be evacuated should also be verified. Changes in these numbers may require changes in the number of guards. The condition of the prisoners should also be verified. Prisoners that are fatigued and/or cooperative do not require as many guards as those that are more highly motivated.

j. Close coordination with the unit holding the prisoners is imperative. The type and amount of transportation is arranged by them. This affects the number of guards required, as well as the route to be taken. It also affects the length of time the movement will take. It may be necessary to coordinate directly with the transportation unit involved. The detail also checks to see that arrangements have been made for rations and water.

k. Enemy activity along the route must be determined. An area of heavy guerrilla activity will require more guards and perhaps additional weapons. All areas are subject to artillery and air attack.

6. Pick Up Procedures. Before MP accept responsibility for detainees, they check to see if the prisoners have been processed and are ready for evacuation. They must be searched again. This cannot be overemphasized. In forward areas it is easy to overlook items. Detainees may also pick up items along the way that may be used as weapons.

a. Detainee tags must be checked. Each detainee must have a completed tag. Detainees may destroy tags while in temporary custody so tags must be checked even though the holding unit may have already done so. The tag should state the date, time, and location of capture. It should include the capturing unit and the circumstances of capture. The name of the prisoner, his serial number, and unit should also be included, if possible. Other information may also be included.

b. Property that has been confiscated should be inventoried. The tag should have the same information as the prisoner tag and a brief description of the item. This includes documents. The description should be sufficient to identify the item. Part C of the standard capture tag (STANAG 2044) is attached to seized property, including documents.

c. The escort detail leader signs for the prisoners on DD Form 2708 (Receipt for inmate or Detained Person), or similar form. More than one prisoner may be listed on the form. The detail leader checks to be sure there are sufficient rations and water for the movement. These are provided by the holding MP unit.

7. Evacuation. Prisoners can be evacuated on foot, by vehicle, rail, water, or air. Regardless of how the prisoners are moved, certain procedures remain the same. Every effort must be made to keep the prisoners segregated. Conversation with the prisoners is only that required to affect the move. It is also helpful to tell the prisoners what is going on. Detailed information of an intelligence value should not be provided. They can be told that they are to be moved further to the rear for their safety, however. This helps lessen their fear of the unknown and tends to make them a little more cooperative. The interpreter should cover march discipline, actions in the event of an emergency, and the meaning of the English word "halt." If not already known, the guards may be taught the word "halt" in the language of the prisoners. The final step before departure is to contact the receiving facility. They should be advised of any changes in the number of prisoners or in the route. They should also be given the estimated time of arrival.

a. Evacuation is a process used whenever moving personnel regardless of status. These are the planning considerations when your unit has been tasked with a detainee evacuation mission. These are very important to you as a platoon leader since you will actually be the planner for the evacuation. It is imperative that detainees, as well as guard personnel, be briefed regarding discipline and actions to take during emergencies. Since EPW are not likely to speak English, the task of disseminating this information will be even more difficult.

b. Emergencies.

(1) Escapes. Attempted escapes must be expected and prepared for. If a guard sees a prisoner attempting to escape, he shouts "halt!" If the prisoner fails to stop immediately, the guard shouts "halt!" a second time. If the prisoner still does not stop, the command is shouted a third time. After the third time, the guard may open fire. He should only do so if there is no other way to stop the escape. Guards should shoot to wound, unless they are in imminent danger. The remaining guards halt the column and secure the other prisoners. When prisoners attempt to escape during emergencies, the closest guard recaptures them. The minimum amount of force is used. If the column is moving in vehicles when an escape attempt is made, the convoy stops. Once the prisoner is recaptured, security around him is increased and the column resumes its movement.

(2) Ambushes. Actions to be taken during ambushes must be planned in advance. Guards should be fully briefed. When possible, the actions to be taken should be rehearsed. One element is designated to control

the prisoners. The rest of the guards place maximum fire on the enemy positions. If the detail cannot immediately break out of the ambush, support is requested from nearby units. These units were identified during the reconnaissance and coordinated with ahead of time. When necessary, indirect fires are called for. Reasonable precautions should be taken to protect the prisoners without endangering the guard force or allowing them to escape. If the column is moving by vehicle, the drivers drive out of the kill zone. Drivers not in the kill zone stop. A pre-designated element engages the enemy. Other guards concentrate on safeguarding the prisoners. Assistance is requested as necessary.

(3) Air Attack. Air attack may be expected throughout the modern battlefield. Guards should have been fully briefed and rehearsed as to what actions to take. One element secures the prisoners. The rest of the guards place the maximum fire possible on the attacking aircraft. When moving by vehicle, actions are similar. The vehicle moves off the road to the best covered and concealed position available.

8. Movement by Foot. Movement by foot is the least preferred method for transporting detainees. Movement by foot is often used when it is necessary to move detainees from the point of capture to the IDCP. Distances normally do not exceed 5 miles. If movement by foot must occur, ensure that detainees are fully ambulatory and have the appropriate footgear. Movement by foot is not used for uncooperative detainees.

9. Movement by Wheeled Vehicle. Movement by vehicle is the most common and most reliable method of transporting detainees. If possible, avoid using team vehicles. Conceal detainees using tarps or window covers when possible. Guards should always be placed to the rear of vehicles with open tops or backs. Conduct a search of the vehicle for any potential weapons or contraband before loading the detainees. Escort security vehicles should be considered as well as front, rear, and flank security.

10. Movement by Bus. During a bus movement (see figure 2-1), planners should plan for two detainees per seat. Do not allow detainees to stand, sit, or lie on the floor; lock doors from external threats. Use window covers when available.

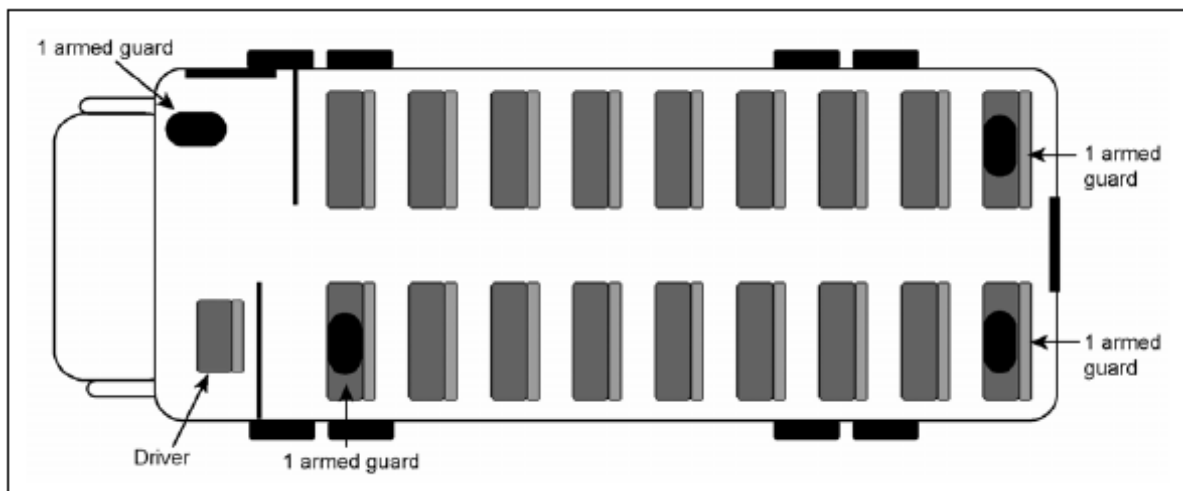

Figure 2-1. Movement by Bus

11. Movement by Cargo Truck Transport. The use of a tarped vehicle (see figure 2-2) is the preferred method when transporting detainees. Tightly position detainees along the bench seat without restraining them to the bus infrastructure or other fixed objects. Soldiers should not allow detainees to stand, sit, or lie on the floor of the vehicle.

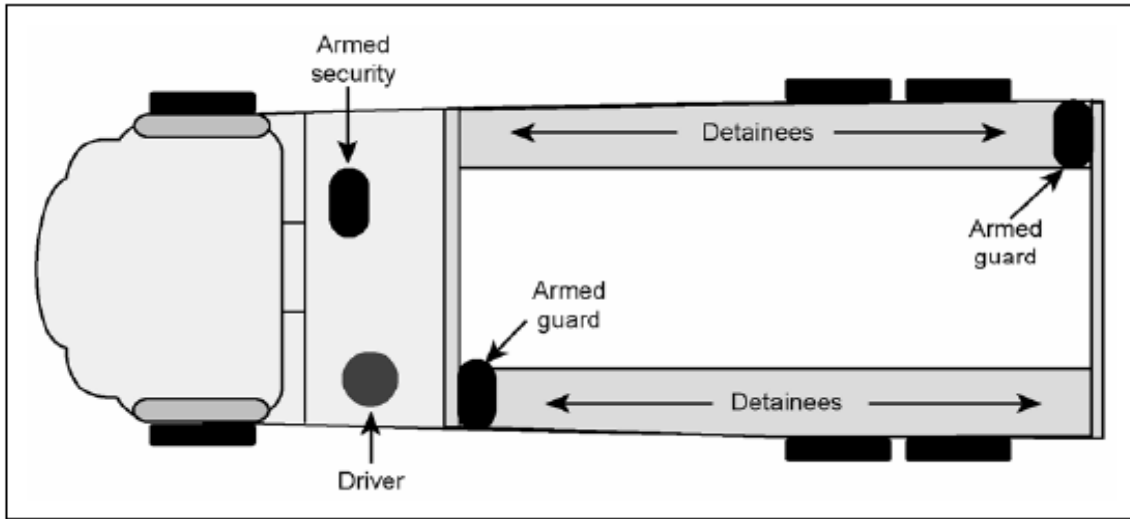

Figure 2-2. Movement by Cargo Truck Transport

12. Movement by Rail. Movement of detainees by rail (see figure 2-3) is rare and available only in industrialized HN. The disadvantages to movement by rail include that trains are easily disrupted by Improvised Explosive Devices (IED), detainees require additional transportation to the rail stations or other stopping points, and the mission is vulnerable at critical sites during transport. During movement, position mobile security teams at critical urban crossing sites, bridge crossings, and at stations or other stopping points, if possible. Conceal detainees using rail cars and window covers when possible, and always position guards at the rear of open-top rail cars. R should be searched thoroughly before boarding detainees, and detainees should never be restrained to the rail car infrastructure. Loading and seating arrangements are based on the size and configuration of the rail cars.

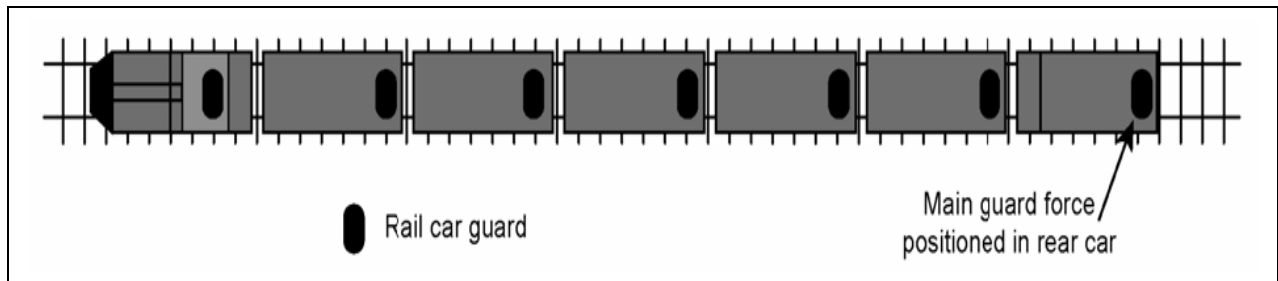

Figure 2-3. Movement by Rail

13. Movement by Air. The critical planning factor to remember during air transport (see figure 2-4) is that the aircraft commander is in charge of that aircraft and will likely dictate how the transportation and security of detainees will be enforced. Some of the disadvantages to air movement are that it requires additional training and rehearsals, is weather dependent, requires a higher guard to detainee ratio, and often entails different ROE (do not use firearms aboard an aircraft). An advantage to air movement is the speed with which a detainee is moved off the battlefield.

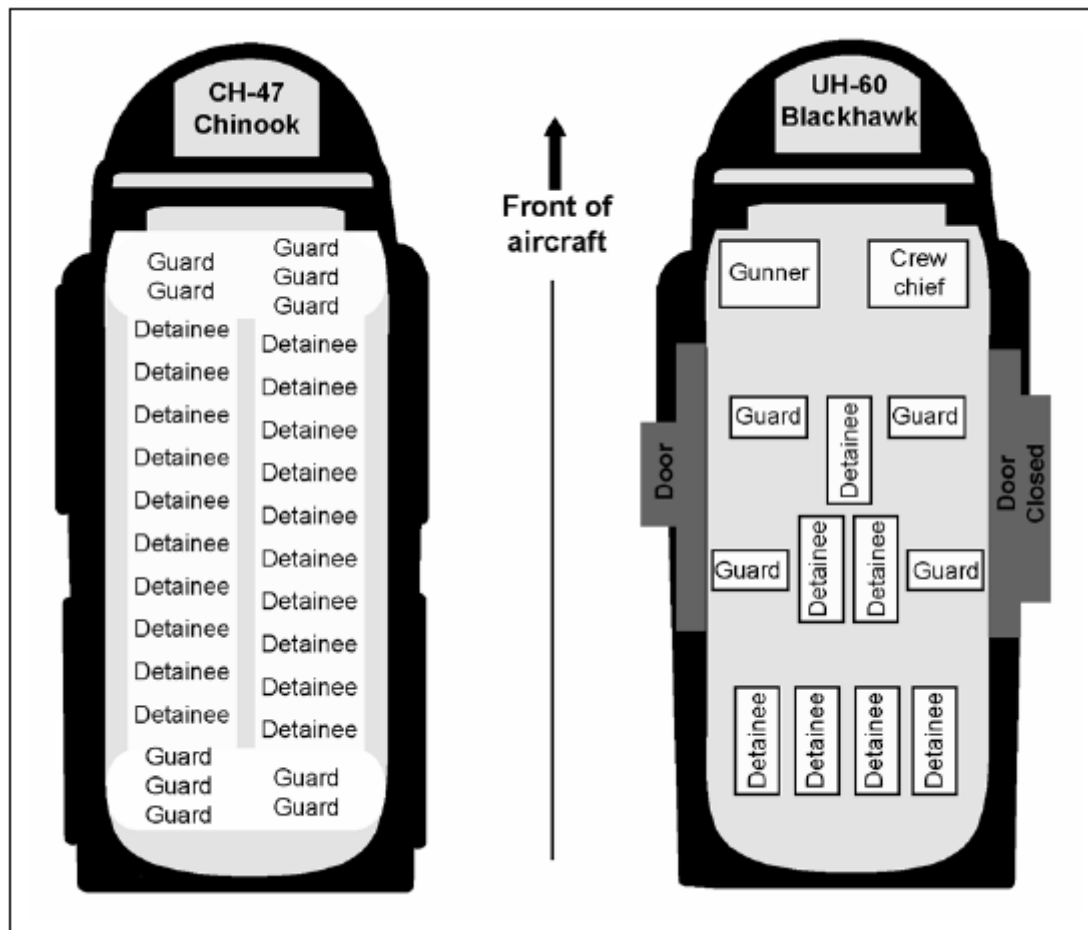

Figure 2-4. Movement by Air

14. Two methods for evacuation out of the European theater to CONUS are by air or sea. The most likely type of aircraft will be commercial planes that are part of the Civilian Reserve Air Fleet (CRAF), after the Noncombatant Evacuation Operation (NEO) has been completed.

PART B - Detainee Collecting/Holding Areas.

1. Initial Detainee Collection Point (IDCP). The number of MP teams needed to operate an IDCP is based on the number of detainees expected and Mission, Enemy, Terrain and Weather, Time, Troops Available and Civilian (METT-TC). The projected number of detainees is based on mission analysis and intelligence estimates. IDCP are mobile and can set up quickly, expand, and relocate as the tactical situation dictates. The general location of an IDCP is normally identified in the Operation Plan (OPLAN) or Operation Order (OPORD) (see figure 2-5). Detainees will be held at the IDCP until MI exploitation has been exhausted and transportation becomes available for either release or transportation to the DHA or, in some cases, directly to the TIF.

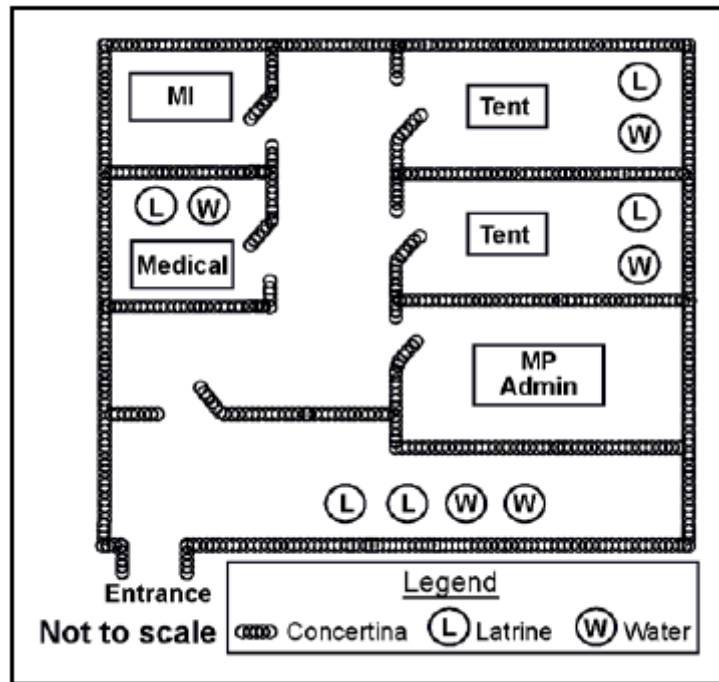

Figure 2-5 Initial Detainee Collection Point

a. Location. The IDCP is located near or in the BCT support area. It is normally located in an area that prevents detainees from observing activities within the BCT support area. IDCP are located close to the Main Supply Route (MSR), making detainee delivery and evacuation easier. An IDCP may also be established where actual combat operations are occurring; for example, during a cordon and search operation, the MP platoon may setup an IDCP near the cordon area.

b. Human Intelligence (HUMINT) Support. While in the IDCP, all HUMINT and/or CI units and personnel are under Operational Control (OPCON) of the MP platoon leader, but under the technical control of an Operational Management Team (OMT) or Assistant Chief of Staff, HUMINT section (G2X). The MP platoon leader should not establish intelligence priorities for the HUMINT and/or CI personnel, nor should he compel HUMINT and/or CI personnel to involve themselves in non-intelligence activities.

c. Medical Support. Coordination with the Detainee Operations Medical Director (DOMD) is required for medical support to the IDCP. At I/R facilities, most Level I and Level II medical support is provided by medical personnel that are part of MP units (under the technical control of the DOMD) or by medical units providing medical area support. All Level III medical support is provided by medical units providing area medical support. Medical care at the IDCP is given according to necessity and limited to emergency medical care only. Detainees more than first aid, combat lifesaver, and Level I medical care are transported to a location where they can receive the appropriate level of care. The level of care provided depends on the situation and the location of the IDCP, DHA, or the facility. The levels of care may be characterized as follows:

- (1) Levels I and II care provide—
 - (a) Daily (sick call) routine care
 - (b) Monthly health assessments
 - (c) General and comprehensive dental care
 - (d) Simple lab work

- (e) Optometry
 - (f) Portable radiology
- (2) Level III care provides—
- (a) An intensive care unit
 - (b) An operating room
 - (c) A radiology unit and a full lab

Medical personnel will promptly report suspected abuse of detainees to the proper authorities as outlined in medical policies developed for detainee operations. Generally, information pertaining to medical conditions and care provided to patients, including medical care for detainees, is handled with respect to patient privacy. Under US and international laws, there is no absolute confidentiality of medical information for any person, including detainees. Behavioral science consultants are authorized to make psychological assessments of the character, personality, social interactions, and other behavioral characteristics of interrogation subjects and to advise authorized personnel performing lawful interrogations regarding such assessments. Those who provide such advice may not provide medical care for detainees except in an emergency when no other health care providers can respond adequately. All psychologists and behavioral health technicians serving in behavioral science consultant positions should receive structured training on their roles and responsibilities while functioning in this capacity. In addition, MI personnel should clearly understand the defined roles, responsibilities, and limitations of behavioral health personnel.

d. Planning considerations. An IDCP is seldom set up near the indigenous population to prevent problems caused by the presence of detainees in the area. IDCP are generally nothing more than a guarded, roped-off (with concertina or razor tape) area or a secured building. The capture rate and the number of detainees determine the size of the IDCP. The use of existing structures, like vacant schools, apartments, or warehouses (when available) is encouraged. This conserves resources and provides protection for detainees. When selecting an IDCP, consider—

- (1) Detainee security capabilities
- (2) Medical support capabilities
- (3) requiring Food and potable water availability
- (4) Field sanitation (latrine) facilities capabilities
- (5) Shelter availability
- (6) Cover capabilities

Note: Detainees can dig or build cover to protect themselves from direct and indirect fire.

2. Detainee Holding Area (DHA). The DHA is normally located in a safe and secure area that is accessible for the receipt and evacuation of detainees. It is a temporary location to field-process and house detainees and provides resources for intelligence exploitation. It is generally comprised of a semi-permanent structure designed and resourced to house detainees. Basic infrastructure elements include shelter and/or cover, latrines,

basic hygiene facilities, and medical care. The DHA (see figure 2-6) is operated by MP assigned under the division maneuver enhancement brigade. The MP operating the DHA has OPCON over HUMINT collectors, medical personnel, and other personnel who operate inside the DHA. HUMINT and counterintelligence collectors screen all arriving detainees to determine which detainees have immediate tactical intelligence value to the maneuver commander (see figure 3-11, page 3-16). MP, MI, and medical and legal assets normally collocated at the DHA provide the following functions:

- a. Detainee security
- b. Detainee housing
- c. Additional segregation
- d. Detainee processing
- e. Tactical interrogation
- f. Medical screening
- g. Custodial care (such as feeding and hydration)

Planners should use existing hard structures, if they are available, instead of constructing new ones. There should also be a well-defined outer perimeter to provide security and force protection. Engineers may have to build guard towers and improve fighting positions. Additional structure design considerations are as follows—

- a. An entry point into the DHA
- b. A reception area for custody transfer operations
- c. An administrative area
- d. A medical support area
- e. An interrogation area/facility
- f. A centralized property room (for evidence, found property, and confiscated property)
- g. Open compounds. Single-cell units for disciplinary segregation

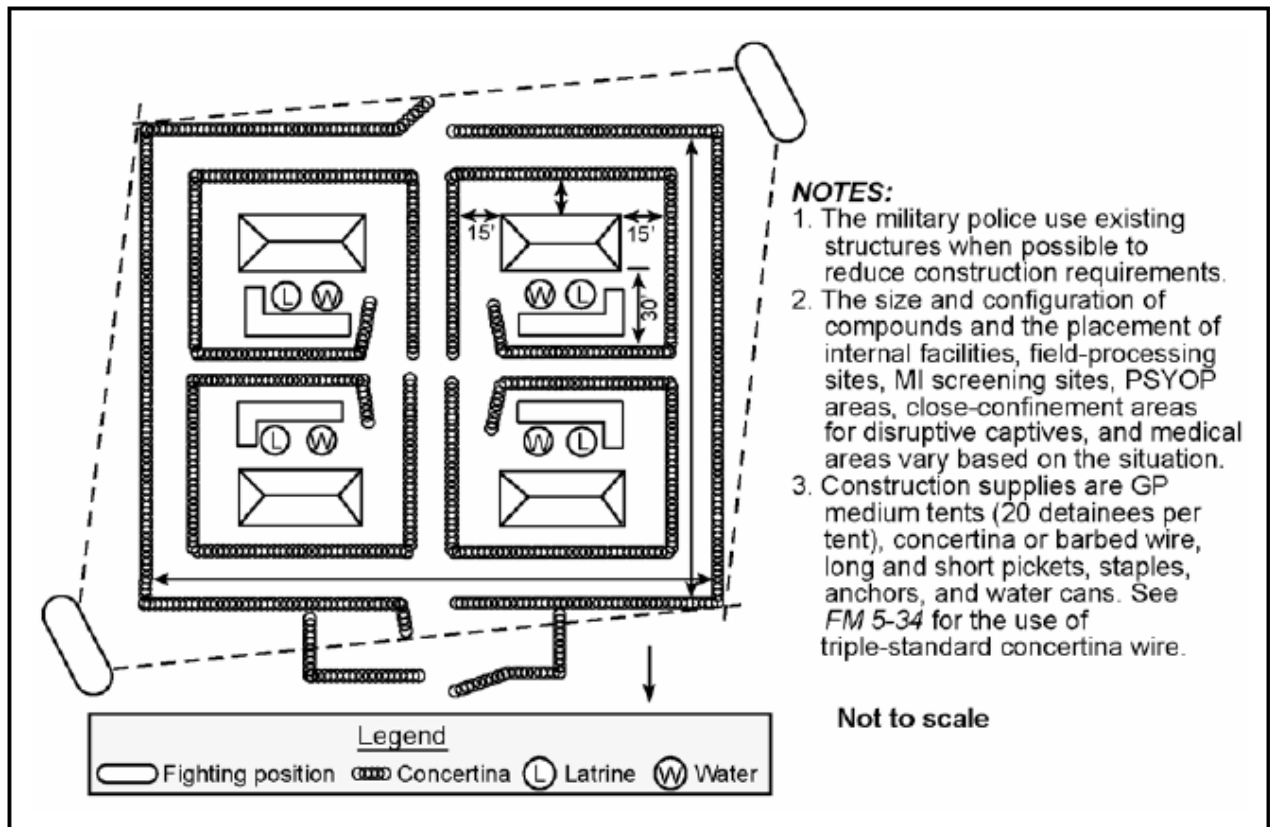

Figure 2-6. Example of a DHA

A sufficient guard force should be based on the area and facility structural design, number of detainees, segregation requirements, and level of detainee threat and risk. Accordingly, a guard force should consist of, at a minimum, a sergeant of the guard, tower and static guards, roving guards, escort guards, and a reaction force. Detainees are not given a determined status at the DHA. All detainees are given EPW treatment at all times and locations until their status are determined according to DoD policy. Detainees should be held until MI exploitation has been completed and transportation becomes available for either release or transfer of the detainee to the TIF. If possible, HUMINT collectors should be available at the DHA. For HUMINT support at the DHA, all HUMINT and/or CI units and personnel are under OPCON of the MP company commander, but under the technical control of an OMT or G2X. The MP company commander should not establish intelligence priorities for the HUMINT and/or CI personnel, nor should he compel HUMINT and/or CI personnel to involve themselves in non-intelligence activities.

3. Theatre Internment Facility (TIF). The TIF is a permanent or semi-permanent facility (normally located at the theater level) that is capable of holding detainees for extended periods of time. A TIF is a long-term internment facility that is run according to all applicable laws and policies. It is possible that detainees and/or enemy combatants may bypass an IDCP or DHA and be transferred directly to the TIF. In such cases, all in-processing and assigning of ISN take place immediately on arrival at the TIF. As the DoD's executive agent, the OPMG has responsibility for detainees. This responsibility is then delegated to the combatant commander of the affected area. The combatant commander responsible for detainee operations provides engineer and logistical support for the facility commander to establish and maintain detainee I/R facilities. Planning, coordinating, and establishing I/R facilities must begin during the build-up phase of an operation. This will ensure that the facility is ready to receive detainees at the start of the operation. I/R facility construction must be included in the planning phase of the operation. Whether the I/R facility is built by engineers or contractors, MP leaders and their staffs must be part of the planning process. Each facility must facilitate the appropriate segregation, accountability, security, and support of all detainees. An I/R facility normally consists of one to eight compounds capable of interning 500 people each and is generally of a semi-permanent nature.

a. General. There are four types of I/R facilities: EPW/CI, DC, violent or noncompliant detainees, and US military prisoners. Each facility starts with a modified version, having a limited 25 percent capability (an administrative area and one compound) for startup operations and is then expanded in increments of 25 percent until it reaches the full facility design with maximum capacity. The EPW/CI, DC, and US military prisoner facilities have a maximum-security area with individual cells to provide individual detention when necessary. The violent or noncompliant detainee facility consists of individual detention cells only.

(1) The maximum-security cellblocks consist of portable cells that are stored on pallets and come ready to assemble. Maximum-security cells can be assembled as stand-alone cells or hooked together to form a cellblock. They can be assembled either in a tent or in a hard structure. MP can assemble these cellblocks with minimal engineer support to run the plumbing and electrical systems.

(2) The detainee facility contains an administrative area and up to four 1,000-man EPW/CI compounds, each split into two 500-man compounds (see figure 2-7). The facility is designed to be expandable in 1,000-man increments. The initial facility is constructed with the administrative area and one 1,000-man compound and then expanded by adding (up to three) additional 1,000-man compounds. Each 1,000-man compound must be self-contained with electric and water capability and must be able to be occupied immediately upon completion.

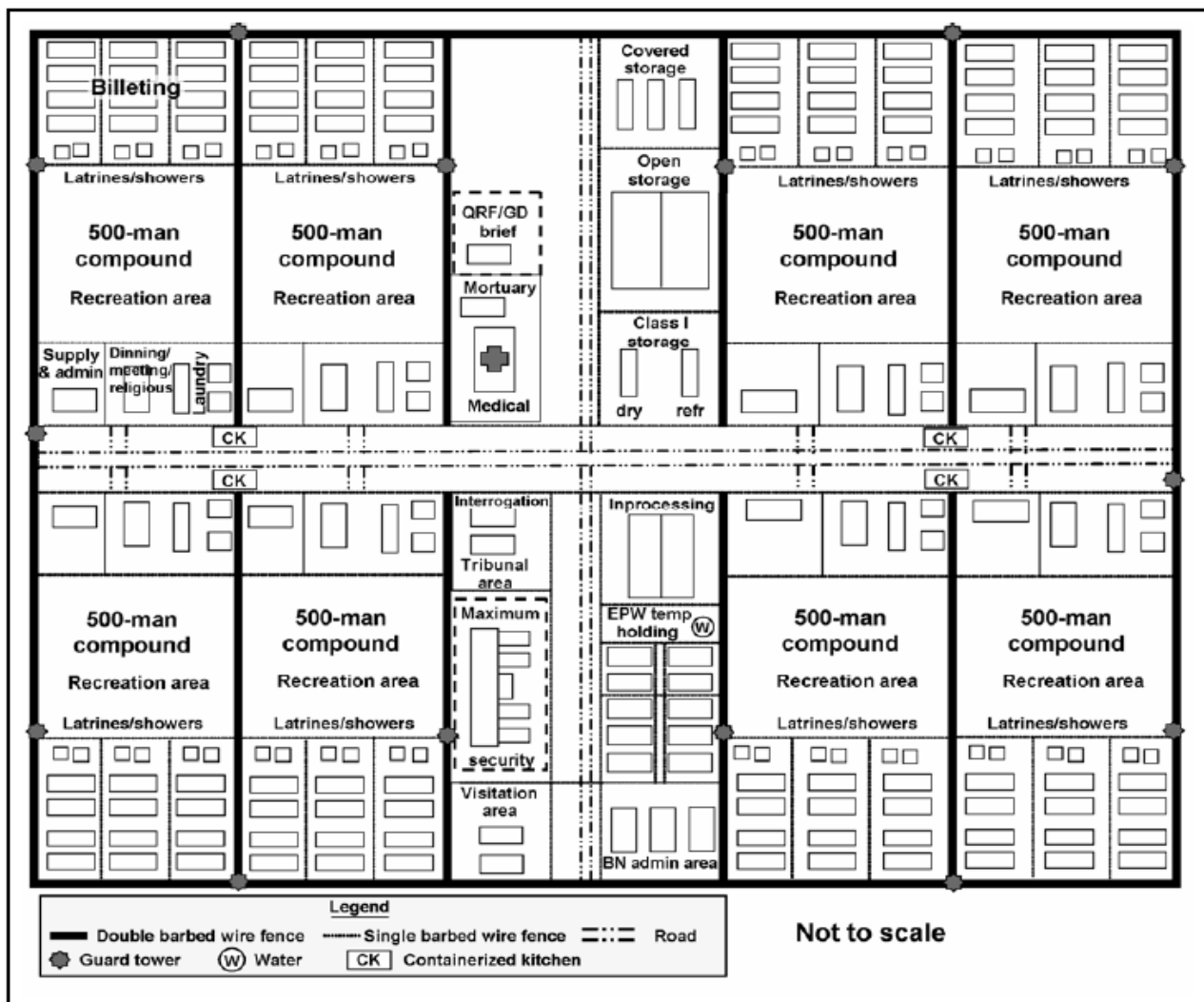

Figure 2-7. 2-555. 4,000-Capacity I/R Facility for Detainees

(3) The I/R facility for DC contains an administrative area and up to eight 1,000-man compounds (see figure 2-8). The facility is designed to be expandable in 1,000-man increments. The initial facility is constructed with the administrative area and one 1,000-man compound and then expanded by adding (up to seven) additional 1,000-man compounds. Each 1,000-man compound must be self-contained with electric and water capability and must be able to be occupied immediately upon completion.

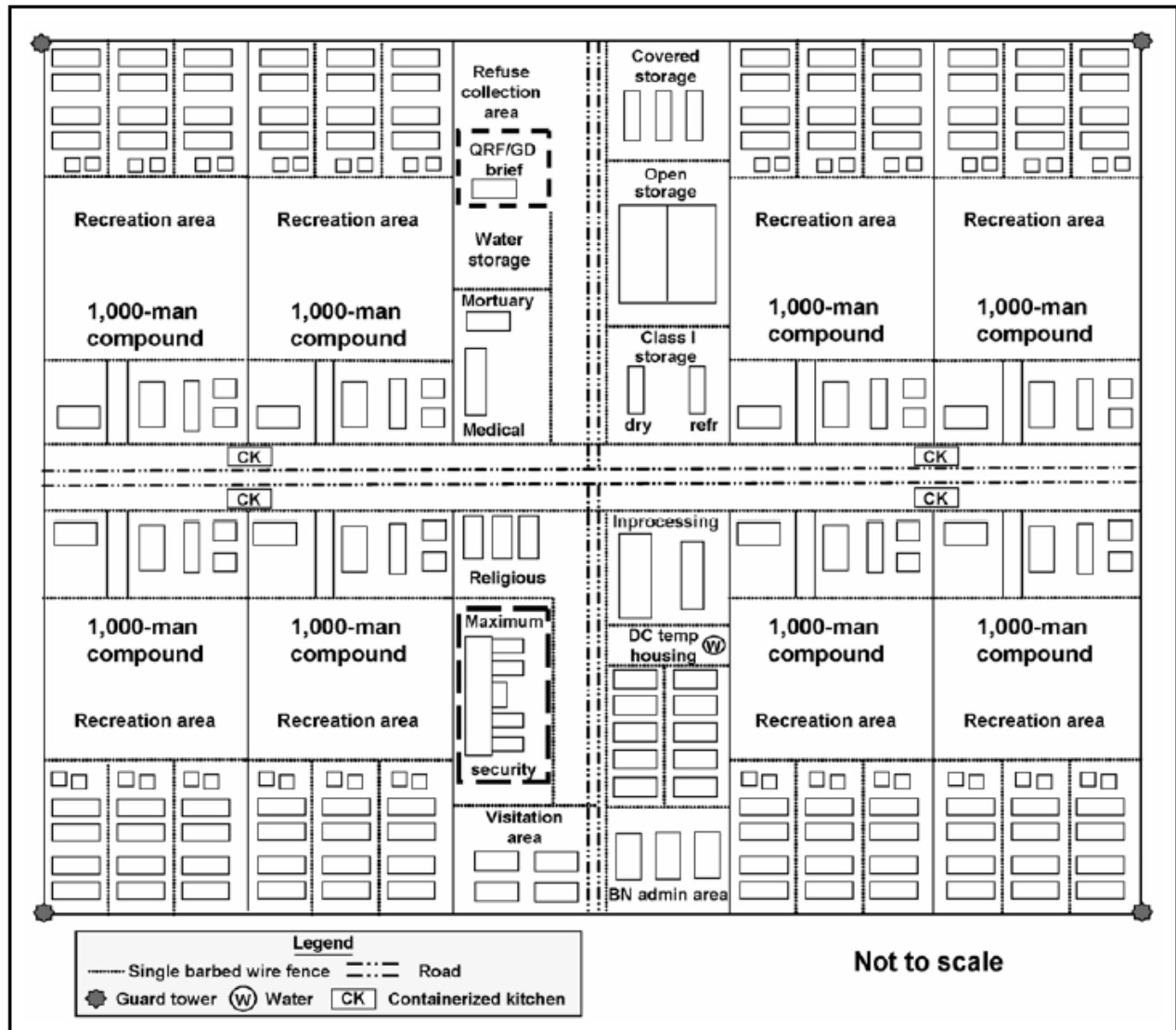

Figure 2-8. 2-555. 8,000-Capacity I/R Facility for DC

(4) The facility for US military prisoners or violent or noncompliant detainees contains up to three 100-man compounds with administrative areas (see figure 2-9). The compounds will be a mix of semi-permanent construction and tented compounds. The decision on the type of compound required is METT-TC driven and is the responsibility of the facility commander. The facility is designed to be expandable in 100-man increments. The initial facility is constructed with an administrative area and one 100-man compound (either semi-permanent or tented construction) and then expanded by adding (up to two) additional 100-man compounds. Each 100-man compound must be self-contained with electric and water capability and must be able to be occupied immediately upon completion. Additional construction requirements for this facility include the following:

- (a) Each cell must have a latrine, sink, and bunk that are attached to the wall.

- (b) Each cell must have solid steel or concrete walls, floor, and ceiling.
- (c) Cell doors must be steel mesh or bars, have a middle and bottom pass-through, and have all hinges and bolts on the outside of the cell.
- (d) Cells can have no exposed plumbing or electrical wiring.
- (e) Cell lights must be shielded.
- (f) Cells must have shutoffs for both electric and water.

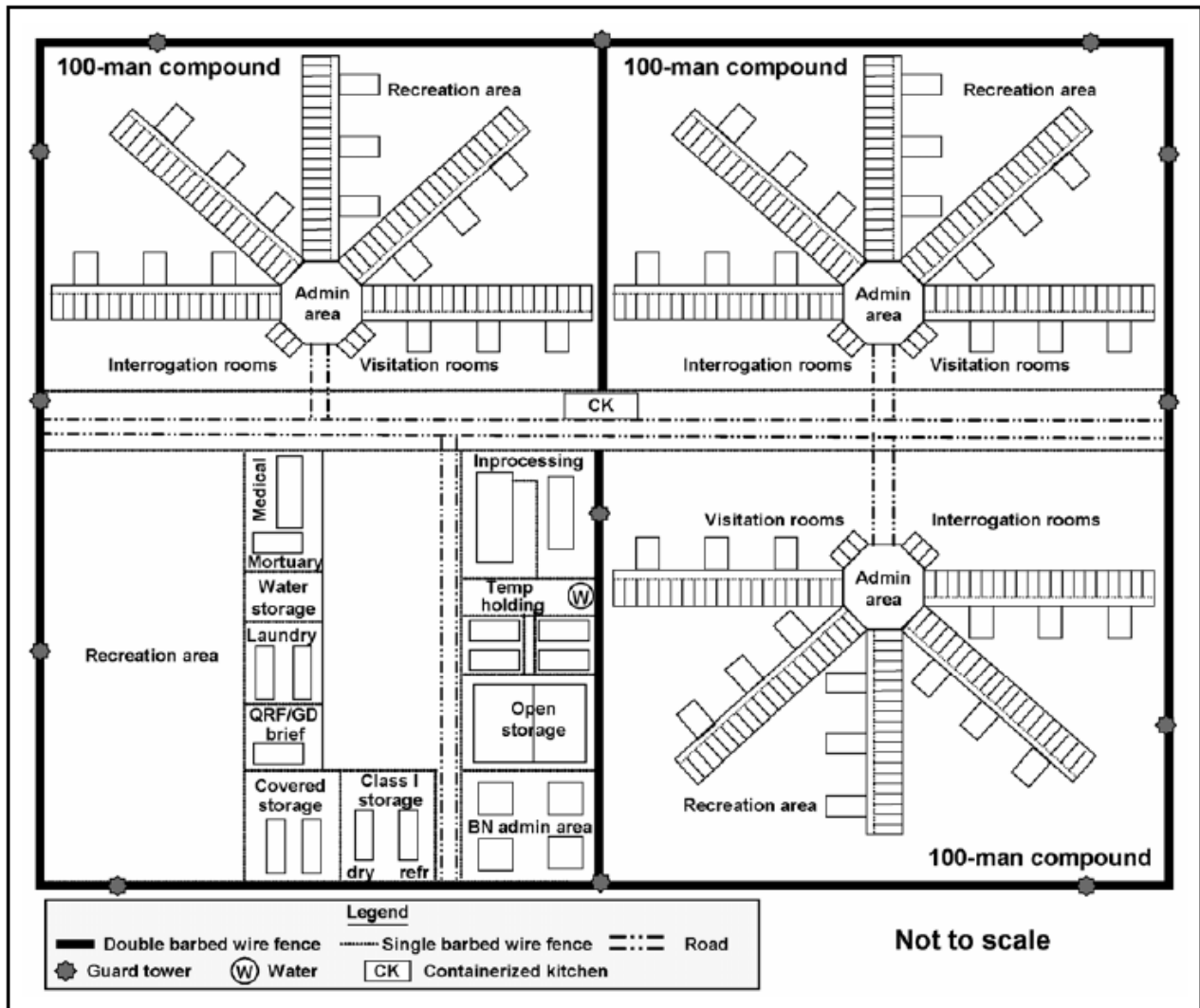

Figure 2-9. 300-Capacity I/R Facility for US Military Prisoners or Violent or Noncompliant Detainees

b. Key organization elements in the TIF may include a joint security group, a joint interrogation group, a detainee hospital, a joint logistics group, and a joint internment operations group. Special staff considerations may include a joint visitor's bureau, a chaplain, the inspector general, the SJA, public affairs, a surgeon, a forensic psychologist, a forensic psychiatrist, a medical plans and operations officer, an environmental health officer, and PM and/or security forces. Two units that provide specific detainee expertise and support to operations at the TIF are the MP brigade liaison detachment (I/R) and the MP camp liaison detachment. When assigned to an I/R brigade, the brigade liaison detachment augments the I/R staff and provides a liaison link to

the allied or HN forces to ensure that the care and handling of US captured detainees is in compliance with international law. The brigade liaison detachment does require support from combat health, legal, religious, finance, personnel, and administrative services. It also requires support from the I/R battalion for the maintenance of organic vehicles and communications and chemical equipment. The camp liaison detachment is normally assigned to the I/R brigade. The camp liaison detachment provides advisory support, as requested by the commanders, and staffs of allied- or HN-operated TIF. It also verifies the arrival of detainees captured by US Armed Forces, based on information received from the brigade liaison detachment. It provides information to the TDRC for input into the DRS for detainee accountability. The camp liaison detachment serves as a coordination link to allied or HN detainee authorities to receive, maintain, and forward records concerning detainees captured by US Armed Forces. The camp liaison detachment can also monitor detainee treatment to ensure that the provisions of the Geneva Conventions, Hague Conventions, and US policy pertaining to detainees are fulfilled.

SUMMARY

During this period of instruction we have discussed the evacuation of detainees and MP responsibilities to ensure proper and humane treatment during movement. We've discussed the various detainee collecting and holding areas and whom they are intended for.

It is crucial to monitor detainee treatment to ensure that the provisions of the Geneva Conventions, Hague Conventions, and US policy pertaining to detainees are fulfilled.

Lesson 2 PE

This practice exercise will measure how much you have learned in this lesson. Select the correct answer to each question. When you are done, turn the page to check your answers.

1) Who is responsible for the collection and evacuation of detainees for US forces?

- a) MP.
- b) Coast Guard.
- c) Marines.
- d) Special Forces.

2) In addition to humane treatment, other principles to be considered in the evacuation of prisoners are as follows:

- a) Prompt evacuation to the rear.
- b) Noninterference with tactical movement of US and allied troops.
- c) Maximum use of returning transportation of all types.
- d) Maximum and timely assistance from higher echelons.
- e) All of the above.

1) Movement by _____ is the least preferred method for transporting detainees.

- a) Aircraft.
- b) Rail.
- c) Bus.
- d) Foot.

2) There are four types of I/R facilities:

- (a) EPW/CI, DC, violent or noncompliant detainees, and US military prisoners.
- (b) Detainees, EPW, enemy combatant, and US military prisoners.
- (c) EPW, enemy combatants, DC, and US military prisoners.
- (d) US military prisoners, EPW, enemy combatants, and violent or noncompliant detainees.

Lesson 2 ANSWER KEY AND FEEDBACK

ITEM CORRECT ANSWER AND FEEDBACK.

1. a. MP.

MP are responsible for the collection and evacuation of detainees for US forces (page 2-3).

2. e. All the above.

In addition to humane treatment, other principles to be considered in the evacuation of prisoners are as follows (page 2-5):

3. d. Foot.

Movement by foot is the least preferred method for transporting detainees (page 2-9).

4. a. EPW/CI, DC, violent or noncompliant detainees, and US military prisoners.

There are four types of I/R facilities: EPW/CI, DC, violent or noncompliant detainees, and US military prisoners (page 2-16).

LESSON 3

Policy and Procedures When Handling Captured Personnel

OVERVIEW

LESSON DESCRIPTION:

In this lesson you will learn to supervise the processing of EPW/CI at an EPW facility.

TERMINAL LEARNING OBJECTIVE:

ACTION: Have an understanding of US and Geneva Conventions policy and procedures in handling detainees.

CONDITIONS: You will have this subcourse.

STANDARD: Demonstrate competency of this task by achieving a minimum passing score of 70 percent on the final subcourse examination.

REFERENCES: The material contained in this lesson was derived from the following publications: Fm3-19.1, FM 3-19.4, FM 3-19.40, FM 5.0, AR 190-8, and DOD Directive 2310.1

INTRODUCTION

Violating international law or US policy concerning detainees cannot only lead to criminal charges against the violator, but also lead to increased manpower requirements for prisoner security. It is important that the MP consistently observe these policies and be prepared to train others in the correct procedures concerning detainees.

Basic US policy towards detainees is derived from the Geneva Conventions and is found in AR 190-8. All persons who are captured, interned, or held by US forces during a conflict must be given humanitarian care and treatment from the moment they are captured until they are finally released or repatriated. This requirement applies whenever the United States is a party to a conflict even if a state of war hasn't been declared.

PART A - United States policy towards detainees.

1. United States policy towards detainees. Current policy dictates that regardless of the characterization of the conflict in which US Armed Forces are present, US Soldiers abide by the law of war, to include the Geneva Conventions and Hague Conventions. This means that US Soldiers provide basic humane treatment, at a minimum, to all persons in their care whether detained for a short term or interned for a long term. Current policy also mandates each person detained by US Armed Forces, combatant or noncombatant, be treated as an EPW upon capture and until his status is fully determined. US policies relating to the treatment of detainees is that all detainees, to include those determined, as a matter of law, not to qualify as "protected persons" under the criteria of the Geneva Conventions, are treated humanely from the moment they fall into the custody or control of US Armed Forces until their final release. DoD Directive 2310.1 establishes the overarching DoD detainee policy and directs that "all detainees shall be treated humanely at all times while in the care, custody, or control of any member of the DoD components," regardless of the status of the detainee or the characterization of the conflict. DoD Directive 2310.1 further directs that "all detainee operations shall be conducted consistent with applicable laws, regulations, and policies." All detainees taken into the custody or control of US forces are treated as EPW according to the Geneva Conventions until some other legal status is determined by a competent authority. In the absence of a controlling party or protecting power, detainees determined, as a matter of law, not to qualify as "protected persons" under the Geneva Conventions are treated in a humane manner consistent with the principles of Geneva Conventions I through IV (1949) and other applicable US laws, regulations, and policies. Detainees who qualify as "protected persons" under one or more of Geneva Conventions I through IV (1949) are treated as required by the applicable convention and other applicable US laws, regulations, and policies.

2. Basic US policies underlying the treatment of detainees, DCs, or US military prisoners held in US Armed Forces' custody during the course of a conflict requires and directs that detainees be accorded humanitarian care and treatment from the moment custody begins until the final release or repatriation. The observance of this policy is fully and equally binding on all US Armed Forces. This policy is equally applicable for the protection of all detained or interned personnel whether they are known to have or are suspected of having committed serious offenses that could be characterized as war crimes. The punishment of such persons is through due process of law under a legally constituted authority. The application of inhumane treatment, even if committed under the stress of combat and with deep provocation, is a serious and punishable violation under national laws, international laws, and the UCMJ. Personnel involved in detainee operations who witness the abuse of a detainee should correct it, report it, and then document the incident for future use. It should be noted that the provisions of the Geneva and Hague Conventions that apply to detainees apply only to international armed conflicts and to the parties of that conflict (see Geneva Convention III [1949]). The Geneva Conventions do not apply during peacekeeping missions and other stability and reconstruction operations. The Geneva Conventions may also apply to certain internal armed conflicts when the parties agree. US Armed Forces who are handling detainees must remember that the distinctions between international, internal, and other armed conflicts carry political ramifications. Therefore, characterizations of conflicts cannot be the sole factor considered when

determining what protection to afford detainees. All commanders must ensure that their plans for handling detainees have been carefully considered by all appropriate legal advisors.

3. General protection of prisoners of war and refugees. The Geneva Conventions for the Protection of War Victims (1949) are comprised of four treaties and are referred to in learning step 2 by number. They were ratified by the United States and came into force on 2 February 1956. The Geneva Conventions provide internationally recognized humanitarian standards for the treatment of victims of war. The US government ratified the Geneva Conventions and recognizes the spirit and intent of these treaties in its treatment of EPW, CI, and detained or interned persons.

4. The provisions of Geneva Conventions I through IV are applicable to detainees. The implementing regulation for these treaties is AR 190-8. When a person is detained during the heat of battle, he must be given the protection to which he is entitled as a detainee.

5. Under all circumstances, detainees are to receive humane treatment without distinction founded on race, nationality, religious belief, political opinions, or similar criteria. Individuals, as well as capturing nations, are responsible for acts that violate the Geneva Conventions.

6. All detainees are entitled to respect. They must be treated with honor and as human beings. They are to be protected against all acts of violence, insults, public curiosity, and reprisals of any kind.

Notes: Detainees will not be murdered, mutilated, tortured, or degraded, nor will they be punished for alleged criminal acts without previous judgment pronounced by a legally constituted court that has accorded them those judicial guarantees that are recognized as indispensable to a fair trial. Do not subject detainees to physical mutilation or to medical or scientific experimentation that is not required for normal medical, dental, or hospital treatment for their proper care.

7. No form of coercion may be inflicted on detainees to obtain information of any kind. Those who refuse to answer may not be threatened, insulted, or exposed to unpleasant or disadvantageous treatment.

8. Female detainees must be protected against any form of indecent assault. Pregnant women and mothers of dependent infants, who are arrested or detained for reasons related to the armed conflict, have their cases considered in absolute priority.

9. Children must also be protected against any form of indecent assault. In cases of arrest or detainment, children must be kept in quarters separate from those of adults except where families are accommodated as family units.

10. All individuals in the custody or control of the DoD during the course of military operations must be treated humanely. Specifically, all persons detained by the DoD must be protected from unlawful acts of violence and must not be deprived of basic human necessities. Accordingly, the US Armed Forces comply with baseline standards derived from the law of war and the longstanding practice of the US Armed Forces during military operations. The US Armed Forces—

a. Treat detainees humanely, without any adverse distinction based on race, color, gender, language, religion or belief (political or other), national or social origin, wealth, birth, or any other similar criteria.

b. Provide sufficient food, drinking water, shelter, clothing, and medical treatment.

c. Allow free exercise of religion, consistent with the requirements of detention.

- d. Will not willfully kill, torture, treat detainees inhumanely, or cause great suffering or serious injury to body or health.
- e. Protect detainees against acts of violence or intimidation and against insults and public curiosity.
- f. Will not subject detainees to physical mutilation or to medical or scientific experiments.
- g. Provide persons, who are detained for reasons related to an armed conflict, the protections afforded according to US and international policies and laws until their final release and repatriation

11. US objectives in handling detainees:

- a. Maximize intelligence information. Proper treatment, particularly immediately after the shock of battle, inclines prisoners to provide information. History has repeatedly shown that improper treatment only causes greater resistance, or just as bad from an intelligence point of view, causes prisoners to tell their captors what they think they want to hear. The information thus gained has little value. The conventions prohibit acts of coercion; they do not prohibit asking questions. In addition to information that the detainee may reveal verbally, his uniform, equipment, and papers he is carrying may reveal a great deal about the enemy.
- b. Prevent escape or liberation. Every enemy soldier captured is one less soldier that our combat forces have to fight. Escapees can also provide a great deal of intelligence information to the enemy forces if their escape or liberation is successful. When prisoners are properly treated, they are less inclined to attempt to escape. It also aids in gaining their cooperation in daily routine, rather than active or passive resistance. Remember that just as it is your duty to attempt to escape when captured, the enemy soldier has the same duty. Your task is to prevent him from succeeding.
- c. By example, promote proper treatment of captured US personnel. Whether we like it or not, US personnel will be captured by the enemy. If we treat enemy prisoners properly, there is a greater likelihood that the enemy will treat our personnel in the same manner. In 1965 the South Vietnamese government tried and executed three North Vietnamese "insurgents." In retaliation, the North Vietnamese executed three US Soldiers they were holding captive. By our example of humane and fair treatment the enemy will do the same.
- d. Weaken the will of the enemy to resist. Fear of mistreatment is a deterrent to surrender. Atrocities embitter and strengthen the will of the enemy to resist. Decent treatment of prisoners encourages others to surrender. There were particularly strong examples of this during both the Korean and Vietnam conflicts.
- e. Use detainees as labor source. The detainee population constitutes a significant labor force of skilled and unskilled workers. Employ detainees to construct, administer, manage, and maintain the facility. The detainees will be employed in other essential work permitted by AR 190-8 only when qualified civilian labor is unavailable. The commander organizes and manages the detainee population in a manner that permits proper, ready employment of each detainee. The commander will establish and maintain a current occupational-skill record for each detainee and include new skills as they are acquired. He assigns individual detainees to a work detail or a job on a regular or permanent basis and establishes vocational-training projects. He also encourages detainees to study and develop skills. The following restrictions apply when employing detainees:
 - (1) An officer cannot be compelled to work.
 - (2) A Noncommissioned Officer (NCO) can only be required to supervise the work of enlisted personnel.
 - (3) A detainee cannot be compelled to engage in work that is purely military in nature and purpose.

(4) A detainee cannot be employed on a work detail that is unhealthy or dangerous because of the work's nature or the individual's lack of physical fitness or technical skill. (See the GPW and AR 190-8 for guidance on this type of employment.)

(5) A detainee cannot be assigned to labor that is considered humiliating or degrading for members of the US Armed Forces. This prohibition does not include unpleasant, necessary tasks that are connected to administering and maintaining the facility.

(6) A detainee cannot be employed or retained in an area where he may be exposed to direct or indirect fire.

Note: If in doubt as to whether work is authorized, request that the SJA review the proposed tasks. This review assures compliance with AR 190-8 and the law of land warfare.

(7) The detainees are compensated when they perform work for which pay is authorized. The rate of pay is not less than that prescribed in the GPW [AR 310-50]. Compensation for work is authorized from US Army appropriated funds, canteen funds, or EPW funds. The EPW are paid for various types of authorized work, such as:

(a) Labor performed for a contract employer or a federal agency.

(b) Services as orderlies and cooks for officer EPW.

(c) Services to construct, administer, manage, and maintain detainee facilities, branch facilities, and hospitals when such services are performed by detainees permanently assigned to certain duties or occupations.

(d) Labor performed by RPs.

(e) Spiritual or medical duties.

(f) Services as detainee representatives or assistants. These individuals are paid from the detainee fund. If a detainee fund does not exist, they are paid from US Army appropriated funds.

(g) Services as detail leaders or interpreters.

(8) The Geneva Conventions state that the detaining power shall grant EPW a monthly advance of pay, the amount of which shall be fixed by conversion into the currency of the said power, of the following amounts:

(a) Category I (EPW below the rank of Sergeant [SGT]): 8 Swiss francs.

(b) Category II (SGT, other NCOs, and EPW of equivalent rank): 12 Swiss francs.

(c) Category III (Warrant Officers [WO], commissioned officers below the rank of Major [MAJ], and EPW of equivalent rank): 50 Swiss francs.

(d) Category IV: (MAJ, Lieutenant Colonels [LTC], Colonels [COL], and EPW of equivalent rank): 60 Swiss francs.

(e) Category V (General Officers [GO] and EPW of equivalent rank): 75 Swiss francs.

Note: The facility commander consults with the SJA and the finance office when setting up EPW advance-pay accounts.

(9) When practical, EPW should raise vegetables for their use; the labor is classified as paid work. Do not overlook the importance of developing an agriculture program. Agriculture and gardening projects are particularly desirable because they provide gainful employment for several individuals. The food produced by gardening projects provides a valuable supplement to diets at minimal expense. The produce from gardens operated with EPW labor is US property. It is used for the benefit of EPW and US Armed Forces personnel, and it is not sold or traded in civilian markets. The types and quantities of agriculture supplies required (seeds, fertilizers, and implements) are procured through the local purchase or Army supply channels. Ensure that necessary supplies are ordered in a timely manner.

Note: The EPW labor that is external to DoD is regulated through contract. (See AR 190-8 for more information on the employment of and compensation for EPW.)

12. Principles in Handling EPW. "The capturing power is the protecting power," Geneva Convention, 1949. This means that when we capture an EPW we must observe certain EPW rights as outlined in the Geneva Convention. It basically ensures that we are responsible for the health, safety, welfare, and humane treatment of all EPW under our control.

13. We want to remove the EPW from the CZ for numerous reasons. We do not want them tying up our combat troops who must safeguard them. If they escape behind our front lines, but are still in the CZ, they can cause numerous problems for us through sabotage, disruption of supply routes, guerrilla warfare, and obtaining intelligence information concerning our forces and activities. We must also ensure that EPW are not injured due to combat operations ongoing in our area of operations.

14. The sooner the military intelligence personnel can begin interrogation of EPW, the sooner we can obtain information which may be used for our own operations. This includes enemy morale, equipment, composition, status, strength, disposition, positions, and future plans.

15. If you handle EPW in accordance with the training you receive during this instruction you will be within the international agreements.

Part B - Geneva Conventions.

1. The Geneva Conventions. The laws of war regulate the conduct of armed hostilities on land. The purpose of the laws of war is to diminish the evils of war. Various instruments have been designed and adopted for the protection and treatment of Prisoners of War (POWs) and civilians detained in times of war and are considered sub-agreements to international humanitarian law. The Geneva Conventions are one such instrument. They are a group of treaties (written contracts) that provide a comprehensive and lawful framework designed to protect combatants and civilians captured during a conflict against acts of violence, intimidation, and public curiosity. Those nations that ratified the conventions are required to uphold them. This appendix describes the intent of protection afforded by each of the four Geneva Conventions, the different categories of detainees under these treaties required by international humanitarian law, and the requirement to establish a tribunal to determine the status of a detainee in question. The Geneva Conventions speak in terms of POWs and DCs. AR 190-8 uses the term detainees to encompass all categories of detained/captured personnel to include EPW, CIs, and RPs. When this appendix addresses detainees, it too refers to all categories of detainees unless otherwise specified. The terminology of the Geneva Conventions is specific to POWs without distinction to EPW. The United States uses the term EPW to identify hostile forces taken captive and reserves the term POW to identify its own or

allied armed forces that have been taken captive. In this appendix, POW is used in the general sense of the Geneva Conventions to encompass all prisoners of war.

2. Intent of Protection. Geneva Conventions I through IV (1949) are each designed with a specific intent of protection. Geneva Convention I covers the protection of sick and wounded Soldiers and those caring for them during times of war; Geneva Convention II addresses injured sailors and shipwrecked victims. Geneva Convention III details the protection and treatment of captured combatants during an international armed conflict. Neither this convention nor any of the other conventions require a formal state of war between two state parties; it only requires that there be an armed conflict, which does not require formal recognition of one state by the other. This stipulation provides the Geneva Conventions with maximum legal effect. For example, the United States considered prisoners of the People's Republic of China to be POWs under the Geneva Conventions during the Korean War, although neither the UN nor the United States recognized the People's Republic of China government at that time. Geneva Convention III (1949) also defines the requirements for POW status and enumerates the protections afforded to that status. Those persons not entitled to POW status under Geneva Convention III are entitled to protections under the Geneva Convention IV, which is considered the cornerstone of modern humanitarian law. Geneva Convention IV, which is relative to the protection and treatment of civilians in the time of war, was amended in 1977 with Geneva Protocols I and II and, respectively, provided further protection for civilians in the time of war. Although the United States has not ratified the protocols, 155 nations have ratified Geneva Protocol I (1967). US commanders must be aware that many allied forces are under a legal obligation to comply with the protocols. US Armed Forces may not be obligated to comply with Geneva Protocol I (1967) provisions that do not codify the customary practice of nations. This difference in obligation has not proved to be a hindrance to US, allied, or coalition operations since the promulgation of Geneva Protocol I (1967). It is the latter two conventions that compel captors to protect and treat humanely all people (detainees [see learning step 1]) who fall into their hands. Geneva Protocol I (1967) extends protections to victims of wars against racist regimes and wars of self-determination, while Geneva Protocol II (1977) extends protections to victims of internal conflicts in which an armed opposition controls enough territory to enable it to carry out sustained military operations. The extended protections of both protocols are in addition to Geneva Conventions III and IV (1949). Besides the conventions and protocols, there are regulations and other international instruments that affect the protection and treatment of detainees during an armed conflict.

3. Humane Treatment - Geneva Conventions I through IV and Geneva Protocols I and II require the humane treatment of detainees. The following five paragraphs, although they are not all inclusive, characterize what is meant by humane treatment.

a. Any unlawful act or omission by the detaining power causing death or seriously endangering the health of a detainee in its custody is prohibited and will be regarded as a serious breach of Geneva Convention III (1949). In particular, no detainee may be subjected to physical mutilation or to medical or scientific experiments of any kind that are not justified by the medical, dental, or hospital treatment of the prisoner concerned and carried out in his interest.

b. Protected persons are entitled, in all circumstances, to respect for their persons, their honor, their family rights, their religious convictions and practices, and their manners and customs. Detainees will be protected against acts of violence or intimidation and insults or public curiosity. Measures of reprisal against detainees are prohibited.

c. Women will be especially protected against any attack on their honor. In particular, they will be protected against rape, enforced prostitution, or any form of indecent assault.

d. Detainees must be kept in facilities under conditions as favorable as those for the forces of the detaining power in the same area. In particular, the premises will be entirely protected from dampness and adequately heated and lighted.

e. At no time will detainees be used to render certain points or areas immune from military operations. They will not be used to lead US Armed Forces in a military operation to determine the enemy's presence or lack thereof.

4. Interrogation. A detaining power may interrogate POWs. POWs are, however, only required to provide their name, rank, birth date, and serial number. POWs cannot be punished if they refuse to give additional information. Article 17 of Geneva Convention III (1949) states that "no physical or mental torture, or any other form of coercion may be inflicted on POWs to secure from them information of any kind whatsoever. POWs who refuse to answer may not be threatened, insulted, or exposed to any unpleasant or disadvantageous treatment of any kind." Noncombatants cannot claim the same protections under interrogation as can POWs, but they are protected from torture and other cruel, inhumane, or degrading treatment as set out under international human rights laws and customary international laws. Some of the instruments relevant to this application include Geneva Convention IV, Article 75 of Geneva Protocol I (considered binding customary international laws by the United States), and the Geneva Convention Against Torture (1984). Article 2 of the Geneva Convention Against Torture (1984), which the United States has ratified, states: "No exceptional circumstance whatsoever, whether a state of war or a threat of war, internal political instability or any other public emergency, may be invoked as a justification of torture."

5. Prosecution. POWs cannot be tried or punished for their participation in an armed conflict. They may be prosecuted for having committed war crimes, crimes against humanity, and common crimes under the laws of the detaining power or international laws. POWs are entitled to be tried before the same courts and face the same procedures that the detaining power's military personnel would face. They are entitled to representation by competent counsel during the trial and must be advised of the charges against them. POWs also have the right to appeal their conviction and sentence. If at the end of a conflict, a POW has done nothing more than to take up arms against opposing military forces, the detaining power is required to repatriate the POW. A POW detained in connection with a criminal prosecution may be repatriated if the detaining power consents. Noncombatants are not afforded the same extensive rights of a trial as POWs. The trial protections they are afforded under Geneva Convention IV (1949) entitle them to a "fair and regular trial." It stipulates that all detainees are entitled to "all the judicial guarantees recognized as indispensable by civilized peoples." This requires that detainees—

- a. Be tried in a "properly constituted, nonpolitical military court"
- b. Be informed of the charges against them
- c. Present their defense and call witnesses
- d. Be assisted by qualified counsel of their own choice
- e. Have an interpreter
- f. Be allowed to appeal the conviction and sentence

6. Categories of Detainees. Detainees captured during an international armed conflict are presumed to be POWs until otherwise determined. In the terms of Article 4, of Geneva Convention III (1949), specified categories of combatants (detainees) who "have fallen into the power of the enemy" are entitled to POW status. These categories include—

a. Members of the armed forces of a party to the conflict and members of militia forces forming part of those armed forces.

b. Members of other militias and members of other volunteer corps (including those of organized resistance movements) who belong to a party of the conflict, operate in or outside their own country, operate under a responsible command, have a fixed distinctive sign such as a uniform or other marking that is recognizable at a distance, carry arms openly, and/or conduct their operations according to the laws and customs of war.

c. Members of regular forces who profess allegiance to a government or an authority not recognized by the detaining power.

d. Persons who accompany the armed forces without actually being members thereof, such as civilian members of military aircraft crews, war correspondents, supply contractors, and members of labor units or of services responsible for the welfare of the armed forces, provided that they have received authorization from the armed forces which they accompany.

e. Members of crews (including masters, pilots, and apprentices of the merchant marine and the crews of civil aircraft of the parties to the conflict) who do not benefit by more favorable treatment under any other provisions of international laws.

f. Inhabitants of a non-occupied territory who spontaneously take up arms to resist the invading forces without having had time to form themselves into regular armed units, provided they carry weapons openly and respect the laws and customs of war.

g. Persons belonging, or having belonged, to the armed forces of the occupied country, if the occupying power considers it necessary by reason of such allegiance to intern them. POWs are afforded the protection of Geneva Convention III (1949) and may not be tried simply for taking up arms against other combatants. They may be tried for criminal offenses unrelated to the international conflict, such as crimes against humanity and war crimes. Detained persons not considered POWs, otherwise noncombatants (generally CIs, and RPs), are denied the provisions of Geneva Convention III (1949). However, they are protected under the provisions of Geneva Convention IV (1949). All detainees are afforded a legal status under Geneva Conventions I through IV (1949). If they are RPs, such as clergy or medical personnel, they are provided the protections associated with that recognition under Article 33 of Geneva Convention III (1949). Geneva Convention I (1949) governs medical personnel of the armed forces, with Geneva Conventions III and IV governing those categories of detainees previously identified. This leaves no detainee without legal status or protection. When the status of a detainee is in question, he will be afforded the protections of Geneva Convention III (1949) until his status is determined otherwise by a tribunal.

7. Tribunals. The categories of detainees who may be considered as POWs are defined in lesson 1 page 1-4. Should any doubt arise as to whether a detainee who has committed a belligerent act and has fallen into the hands of the enemy belongs to any of the categories enumerated in Article 4, a tribunal will be exercised to determine the combatant status of the detainee as required by Article 5. Such a detainee shall enjoy the protection of Geneva Convention III (1949) until such time as a competent tribunal has adjudicated his status. Operation Desert Storm demonstrated this point. Several detainees were believed to be POWs, but through the conduct of tribunals, they were determined to be displaced civilians and sent to refugee camps. No nation has unilateral authority to declare prisoner combatants to be outside the protections of the Geneva Convention III (1949) POW provisions. The determination of the status of each detainee must be made on an individual basis through the conduct of a tribunal, as circumstances may differ for each. A tribunal may also be exercised at the request of a non-POW detainee who is being tried for an offense arising out of the hostilities. Geneva Convention III (1949) states that any person who has committed a belligerent act and thereafter comes into the power of the enemy shall be treated as an EPW unless a competent tribunal determines that the person does not

fall within a class of persons described in Article 4 of Geneva Convention III (1949). When a competent tribunal determines that a detained person has committed a belligerent act and does not fall into one of the classes of persons described in Article 4 of Geneva Convention III (1949), that person will be delivered to the PM—

- a. For disposition according to the rights and obligations of an occupying power under the laws of war (if captured in enemy territory)
- b. For delivery to the civil authorities unless otherwise directed by a competent US authority (if captured in the territory of another friendly state)

AR 190-8 has established procedures for the conduct of a tribunal. A tribunal will consist of commissioned officers, determined by the theater commander, whose responsibility is to determine the status of detainees in question under Geneva Convention III (1949). Detainees whose status is in question will—

- a. Be authorized legal representation
- b. Be advised of their rights at the beginning of the tribunal hearings
- c. Be allowed to attend all open sessions and be provided with an interpreter, if required
- d. Be allowed to call witnesses when reasonably available
- e. Be allowed to question the witnesses summonsed by the tribunal
- f. Be allowed to testify or address the tribunal
- g. Not be forced to testify before the tribunal

Upon the conclusion of testimony and a review of evidence, the tribunal will determine the status of the detainee in question in a closed session by majority vote. A written report will be made of the tribunal's decision for each hearing.

SUMMARY

During this period of instruction we discussed US policy and the Geneva Convention and how they relate to detainee operations.

It is imperative that all MP personnel be proficient in detainee operations. Detainee operations are governed by international law, thus strictly binding us to strict limits of variance. As a platoon leader remember, "A platoon does well, what the platoon leader checks."

Lesson 3 PE

This practice exercise will show you how much you have learned in this lesson. Select the correct answer to each question. When you are done, turn the page to check your answers.

- 1) Detainees captured during an international armed conflict are presumed to be POW until otherwise determined.

- a) True.
 - b) False.
- 2) The Geneva Conventions state that the detaining power shall grant EPW a monthly advance of pay for their employment.
- a) True.
 - b) False.
- 1) POWs are only required to:
- a) Obey the rules of the camp in which he is interned.
 - b) Answer all questions asked.
 - c) Provide their name, rank, birth date, and serial number.
 - d) Provide only name, rank, serial number.
- 2) What type of work are officer EPWs required to do?
- a) Supervisory duties only.
 - b) Construction of their own facilities.
 - c) Gardening to raise their food.
 - d) An officer EPW cannot be compelled to work.
- 3) Identify the type of work that an EPW and CI are not authorized to do:
- a) Construction and maintenance of EPW and CI camps.
 - b) Dangerous, humiliating, or unhealthy labor.
 - c) Domestic service.
 - d) Commercial business and arts and crafts.

Lesson 3 ANSWER KEY AND FEEDBACK

<u>ITEM</u>	<u>CORRECT ANSWER AND FEEDBACK.</u>
-------------	-------------------------------------

1. a. True.

3) Detainees captured during an international armed conflict are presumed to be POW until otherwise determined. (page 3-11).

1. a. True.

The Geneva Conventions state that the detaining power shall grant EPW a monthly advance of pay for their employment (3-7).

2. c. Provide their name, rank, birth date, and serial number.

POWs are, however, only required to provide their name, rank, birth date, and serial number (page 3-10).

3. d. An officer EPW cannot be compelled to work.

An officer EPW cannot be compelled to work (page 3-6).

1. b. Dangerous, humiliating, or unhealthy labor.

A detainee cannot be employed on a work detail that is unhealthy or dangerous because of the work's nature or the individual's lack of physical fitness or technical skill (page 3-7).

