

# CIVIL DISTURBANCE OPERATIONS

Subcourse Number MP 1005

EDITION C

United States Army Military Police School  
Fort McClellan, Alabama 36205-5030

6 Credit Hours

Edition Date: April 2006

## SUBCOURSE OVERVIEW

We designed this subcourse to teach you how to use crowd control techniques and plan for and supervise control forces during a civil disturbance.

There are no prerequisites for this subcourse.

This subcourse reflects the doctrine which was current at the time it was prepared. In your own work situation, always refer to the latest official publications.

Unless otherwise stated, the masculine gender of singular pronouns is used to refer to both men and women.

### TERMINAL LEARNING OBJECTIVE

**ACTION:** Plan for, supervise and employ crowd control forces and techniques for a civil disturbance.

**CONDITION:** You will have this subcourse, paper and pencil.

**STANDARD:** To demonstrate competency of this task, you must achieve a minimum score of 70 percent on the subcourse examination.

### TABLE OF CONTENTS

Section	Page
Subcourse Overview.....	i
Lesson 1: Plan Operations to Control a Civil Disturbance.....	1-1
Part A: Planning.....	1-1
Part B: Troop Support/Training.....	1-13
Part C: Operational Techniques/Application of Force.....	1-17
Part D: Operational Tasks.....	1-28

Practice Exercise.....	1-36
Answer Key and Feedback.....	1-38
Lesson 2: Crowd Control Techniques.....	2-1
Part A: Crowd Control.....	2-1
Part B: Neutralization of Special Threats.....	2-11
Practice Exercise.....	2-26
Lesson 3: Crowd Control Formations.....	3-1
Part A: Types of Formations and Weapons.....	3-1
Part B: Unit Organization.....	3-8
Part C: Squad Formations.....	3-13
Part D: Platoon Formations.....	3-15
Part E: Company Formations.....	3-32
Practice Exercise	
Lesson 4: Riot Control Agent Dispenser.....	4-1
Practice Exercise.....	4-8
Examination	
Appendix: Preventive Maintenance Checks and Services (M33A1)A-1	

## LESSON 1

### PLAN OPERATIONS TO CONTROL A CIVIL DISTURBANCE

#### OVERVIEW

#### LESSON DESCRIPTION:

This lesson is designed to describe the nature and causes of disaffection and social unrest; define the potential for social unrest in the United States; identify the types of confrontations; define crowd behavioral and psychological influences; identify patterns of disorder.

## TERMINAL LEARNING OBJECTIVE:

- ACTION:** Plan operations to control a civil disturbance.
- CONDITION:** You will have this subcourse, paper and pencil.
- STANDARD:** To demonstrate competency of this task you must achieve a minimum score of 70 percent on the subcourse examination.
- REFERENCES:** The material contained in this lesson was derived from the following publications: FM 3-19.15; FM 10-10; FM 3-19.4.

### PART A – PLANNING

1. Mission of Military Forces during Civil Disturbances. The mission of military forces during civil disturbances, both in CONUS and OCONUS, which cannot be overly emphasized, is to help local and state authorities to restore and maintain law and order. This mission may be accomplished by breaking up unauthorized gatherings and by patrolling the disturbance area to prevent the commission of lawless acts. During operations to restore order, military forces may present a show of force, establish roadblocks, break up crowds, employ crowd control agents, patrol, serve as security forces or reserves, and perform other operations as required. Successful fulfillment of the missions will depend to a large extent upon sufficient planning, training, police information, and coordinated actions of individuals and units.
2. Planning and Preparation. To be most effective, planning should be coordinated with local civil authorities to provide a complete coverage of all matters pertaining to operations and ensure that areas requiring joint efforts are properly considered. The provost marshal performs a key role in civil disturbance planning due to the mission of restoring law and order assigned a military force in confrontation management operations. His knowledge of police methods is particularly valuable to the commander and staff in their preparation to assist a community to restore law and maintain order. Considerations should be given to the provost marshal as a member of the advance party to further coordinate and represent the commander with civil police agencies. Planning is a continuing process involving personnel, correct information, logistics, and operational considerations. It provides for action to be taken before, during, and after disturbances. A military unit preparing for confrontation management duty passes through two general phases: the planning and training phase, and the alert phase.
  - a. The Planning and Training Phase. In planning for crowd control or civil disturbance operations, planners must decide what data, equipment and training will be needed in order to respond to the demonstration and restore law and order. This phase includes all preparations that are made prior to the unit being alerted. Included in this phase are preparations of unit alert plans and standing operating procedures (SOP), survey of areas and routes, preparation of plans for probable areas of disturbances, preparation of equipment and crowd control devices to include both non lethal and lethal munitions, training in confrontation management operations, and rehearsals of plans.
  - b. The Alert Phase. This phase may be a short time or may extend over a period of days. During this phase, the unit is fully prepared and ready to move. Vehicles are loaded with equipment and ready for movement. Soldiers are dressed in the prescribed uniforms. Weapons, ammunition, non-lethal munitions, crowd control agent munitions, and supplies are ready for issue. Soldiers must be briefed on the situation and mission to the extent possible in conformance with instructions from higher headquarters. Talks by

company commanders and platoon leaders must prepare the Soldiers psychologically for the forthcoming mission

c. National Guard Units. During the planning phase, National Guard units which may be subject to call for duty should make the preparations prescribed in AR 135-100. Special attention must be given to the orientation of personnel with regard to their status when federalized.

3. Alert Plan. Each organization which may be involved in civil disturbance should prepare a detailed alert plan, based upon expected missions. It must be a logical development of the alert plan of the next higher unit. The plan must provide for an orderly process by which the unit will be brought to a state of operational readiness which will help it to perform its assigned mission promptly and efficiently.

a. The alert plan should be based upon local conditions and whether you are in CONUS or OCONUS. It must be revised as a result of lessons learned and experience gained by rehearsals, or as necessary, to conform to changes in the alert plan of the next higher headquarters. It should include such items as:

- (1) Verification procedures for the warning order.
- (2) Personnel notification procedures and places of assembly.
- (3) Required actions for each element of the organization.
- (4) Procedures for issuing special equipment, supplies, and material.
- (5) Vehicle preparation.
- (6) Security restrictions.
- (7) Administrative details
- (8) Tentative briefing requirements for unit personnel.
- (9) Provisions for opening a unit journal and establishing a journal file immediately upon receipt of the warning order.
- (10) Coordination with civil authorities.
- (11) Reconnaissance.
- (12) Communications.

b. The alert plan must be thoroughly understood by every member of the unit. Each individual must know his duties, those of his next senior, and the unit's mission. He must be prepared to replace his next senior.

4. Standing Operating Procedures (SOP). Procedures for confrontation management operations should be included in unit SOP. In addition, procedures for apprehension, search, detention of persons, seizure of property, obtaining witnesses and statements, crowd control formations, identifying extraction and apprehension teams and reserve forces to assist with crowd control when needed. Additionally it should also identify the type of crowd control equipment to be utilized, and the procedures for employment and use of non lethal weapons and munitions.

5. Organization. The development of an effective force capable of controlling civil disturbances depends largely upon proper organization. The following five principles of organization should be considered in planning for all civil disturbance operations:

- a. Essentiality.
- b. Balance.
- c. Coordination.
- d. Flexibility.
- e. Efficiency.

6. Unit Integrity and Decentralized Control.

a. General. An important aspect of confrontation management is the great number of missions involved which creates the need for forces to engage in a variety of operations at the same time. This is a factor which must be thoroughly planned for and constantly evaluated in the development of an effective control force. The need for immediate decisions is great and the requirement for direct supervision is important; therefore, control must be decentralized. Commanders must develop small units capable of functioning as separate teams, as well as part of the overall force. These small units must be responsive to the changing situation and capable of immediate reaction based on the decisions of their leaders.

b. Unit Integrity. To use small unit capability to the best advantage, organizational development should be based on unit integrity. For instance, for an infantry unit the squad should be considered the basic patrol unit; this gives a platoon (minus the weapons squad) the capabilities of a total of three 10-man patrols and the company (minus the weapons platoon) a total of nine. If smaller units are necessary, the fire team concept should be used. Other types of units may need to organize in a similar fashion.

c. Decentralized Control. For proper development of decentralized control, clearly defined duties should be assigned to the lowest possible level and adequate authority given to the responsible person to permit him to do his job effectively.

d. One of the most important phases of civil disturbance planning is the selection of personnel for confrontation management duty. Personnel selected for this duty should be selected using the following criteria:

- (1) The ability to remain calm under physical, mental, and emotional strain.
- (2) Respect all persons.
- (3) Maintain an impartial, patient attitude.
- (4) Be able to issue orders in a manner crowd members can understand.
- (5) Must not show signs of fear.
- (6) Be in a good physical condition.

e. The noncommissioned officer (NCO) has a tremendous duty in this area. The NCO is usually the person closest to the Soldiers on a day-to-day basis and may be in the best position to see a man who may have become unreliable for civil disturbance control duty. This type of observation is priceless to the commander.

## 7. Logistical Planning.

a. General. Civil disturbance operations involve special consideration for logistical support depending on whether you're here in the United States or overseas. Logistical planning covers all phases of such operations from preparation and training to the end of the mission. Planners must include provisions for necessary supplies, services, and facilities, through local services, if necessary. These may include provisions for food, beverages, ammunition, special crowd control equipment and sanitation facilities.

### b. Equipment and Material.

(1) Individual and organizational equipment prescribed in common tables of allowances (CTA) and tables of organization and equipment (TOE) for Soldiers and units usually are sufficient for civil disturbance control operations. Additional you may add non-lethal munitions to your existing organic weapons systems such as the M203. For example, adding the M9 pistol for the extraction and apprehension teams, a M16 or M4 with a 203 attached, or a 12 gage shotgun with non lethal munitions capabilities. The shotgun with non lethal capabilities can be utilized by the over watch personnel. Other examples of additional equipment which may be needed are armored vehicles, mechanical crowd control agent dispersers, floodlights, spotlights, searchlights, cameras of the Polaroid type, movie cameras, public address systems, heavy construction equipment, aircraft, ambulances, first aid kits, firefighting equipment, grappling hooks, ladders, ropes, special weapons, communications equipment, and recording devices. Equipment that will not be needed should be left behind.

(2) Plans must also provide for a supply of barricade and roadblock materials and equipment such as: heavy single strand wire, barbed wire, concertina wire, heavy stakes, heavy nails and spikes, and power saws. Signs and sign making materials, including quick-drying paints, must be available for use with barricades and roadblocks

(3) Unit-Accompanying Supplies. Preparation of unit-accompanying supplies and equipment is important for rapid reaction in emergency situations. Among the items which must be provided for are ammunition, food, water, gasoline, lubricants, spare parts, crowd control agents, maps, and administrative supplies. Unit-accompanying supplies should be developed with unit integrity in mind. A running inventory must be kept and complete inspections made as necessary. Based upon the characteristics of each item, a procedure for periodic exchange of certain items should be established. For example, crowd control agents, ammunition, foodstuff, and gasoline deteriorate in prolonged storage. Retention of unserviceable materials will have grave consequences in the event of an emergency. Further, ammunition should be kept apart by type as well as lethal and non lethal

c. Transportation. Plans must provide for all types of transportation needed in civil disturbance operations. In developing transportation requirements, consideration must not be given only to requirements of deployment, but must also include requirements within the disturbed area. Commercial buses for mass transportation within the objective area, and the use of rental sedans should be considered. TOE vehicles should be increased as necessary to provide sufficient flexibility and mobility for operational and support elements. In this regard, transportation units are to be considered in the task force development.

d. Maintenance. Considerations should be given to expanding the existing maintenance capability of the unit. Particular attention should be given to replacement of windshields, tires, rearview mirrors, lights, and

radio antennas. Coordination should be made with the field maintenance facility to establish maintenance and evacuation procedures after the unit is committed.

e. Re-supply. Definite procedures must be established for re-supply in the objective area. Consideration should also be given to the establishment of logistical contact teams in the objective area. These contact teams should have direct communications with support units so that critical supplies can be obtained as soon as required with a minimum of delay. Priorities for requisitions should be established to afford the maximum response to requests for re-supply.

f. Loading Plans.

(1) Personnel Loading Plan. To ensure the disturbance control force arrives in the objective area prepared for immediate employment, commanders must develop personnel loading plans around the principle of unit integrity. Loading plans must be rehearsed and should become SOP within the unit. Personnel loading plans must be developed for each mode of transportation mentioned above.

(2) Equipment Loading Plan. Attention to unit integrity also must be given the equipment loading plan. Each element of the force must be escorted by its required equipment and a small reserve of ammunition, crowd control agents, and basic supplies.

g. Medical Facilities. Plans must provide for the provision of emergency medical attention to military personnel and civilians. Plans should provide for qualified personnel, ambulance service, medical and civilian, whenever possible.

8. Operations Planning.

a. Prior to deploying the control force, a counterdemonstration working group should be developed to coordinate the resources that will need to be employed by the task force (TF). Detailed planning for the procedures used in civil disturbance operations at each level of command should include provisions to implement plans of the next higher echelon. This working group should include:

(1) Public Affairs

(2) Joint military commission (JMC), if organized

(3) Provost marshal office (PMO)

(4) G2, Assistant Chief of Staff nG5 (Civili Affairs) (G5), Assistant Chief of Staff G-6 (signal) (G6)

(5) PSYOP

(6) Civil Affairs

(7) Army Airspace command and control (A2C2)

(8) Chaplain

(9) Engineer

(10) Surgeon

## (11) Fire support element

b. Plans should be prepared for each probable major operational area. These plans should be based on a physical reconnaissance whenever possible. Each plan should indicate an assembly area with primary and alternate routes thereto, tentative locations of road-blocks and observation posts, temporary quarters for billeting and feeding, a patrol plan, a security plan for certain facilities, and other such details. Maps, overlays, aerial photographs, and sketches should be obtained and necessary plans developed for distribution and reserve stockpiling.

c. An outline should be provided for command and control of joint operations with civil authorities to include joint patrols, exchange of equipment, etc. Full use of existing civil police operational limits will prove helpful for adjusting and sending Soldiers for best area coverage.

9. Movement. Movement to the main areas must be considered in developing operations plans. The disturbance control force is extremely weak during movement and could receive a substantial setback if rioters disrupt the movement route and debarkation points. En route security, to include aerial observation, must be provided at such places as over-passes, high buildings, and other vulnerable points. Further, the means of movement is critical to the success of the operation because of the time factor involved. Normally, Soldiers will be committed to civil disturbance missions on extremely short notice and must arrive promptly if the disturbance is to be contained with minimal damage to property and injury to persons. Since rioters can apply tactics which will delay the arrivals of Soldiers, the most direct routes are selected which are least vulnerable. Alternate routes must be planned for.

10. Assembly Areas. Movement planning must include the advance selection of areas for assembly of units and the accounting for personnel and checking equipment. Assembly areas should be sufficiently removed from the disturbed areas to preclude their being engulfed by the riotous element.

## 11. Bivouac Areas and Billets.

a. The selection of bivouac areas and billets should be based on the following desirable characteristics:

- (1) Close distance to disturbed area.
- (2) Large enough to avoid congestion.
- (3) Relatively easy to secure.
- (4) Adequate primary and alternate routes available to the scene of disturbances.
- (5) Adequate sanitation facilities.
- (6) Communications facilities.

b. Whenever possible, maximum use of federal, state, or public property should be made in order to stop extra claims for property damages and displeasure among the public. The use of public schools provides excellent billeting, communications, water, and sanitary facilities. However, if school is in session, use of schools may act as an irritant to the public. National Guard armories and Reserve Centers are ideal if available.

12. Command Posts. Locations for command posts should be selected in advance and plans prepared for staffing and equipping them with a minimum of delay. Consideration should be given to both the main



command post and to tactical command posts within the various subdivisions where rioting is most likely to occur. Security measures must be taken to ensure command posts are not penetrated or overrun by unruly elements. Collection of military and civil police command elements from highest to lowest level represents the best solution to the problem of command and control because of joint aspects involved. Consideration should be given to use of police precinct stations for collocated command posts because of their strategic locations throughout the entire area. Collocation of command posts in this manner facilitates continuing coordination between military and civil authorities.

13. Army Aircraft. Operations planning includes consideration for the use of Army aircraft (helicopters and fixed-wing) for command and control, communications, observation, reconnaissance, en route security, distribution of crowd control agents, controlling the movement of units, removing casualties, movement of Soldiers, re-supply, dropping leaflets, airborne loudspeaker broadcasting, and other appropriate requirements. Plans should include searchlight-equipped observation helicopters to be used in organizing ground patrols to ensure complete coverage day and night.

## PART B - Public Relations and Information.

### 1. Public relations.

- a. Civil disturbance plans must include provisions for furnishing commanders in the area of operations with the personnel and equipment resources necessary to conduct information activities.
- b. In order for public relations with the press to run smoothly, plans should provide for:
  - (1) Giving accredited media representative's locally devised press passes that will make their passage through police lines and military checkpoints easier.
  - (2) Coordinating press requests for coverage of operations in the disturbance area to include arrangements for furnishing military personnel to act as press escorts where necessary.
  - (3) Establishment of a press room by the public affairs officer of the task force commander. This facility should be used for periodic press briefings and as a central point for giving the press unclassified information in the form of fact sheets and other background data concerning the operation.
  - (4) To keep Soldiers informed, plans should include:
    - (a) Arrangements for preparation and issuance of a daily fact sheet by the public affairs officer of the force commander.
    - (b) Arrangements for giving participating units free copies of local and regional newspapers, if practical.
    - (c) Answer press questions.
  - (5) Battalion and larger size units in the area of operation must be capable of:
    - (a) Responding to press questions or providing the public affairs officer of the next higher headquarters with correct data about the unit.
    - (b) Providing press escorts.

## 2. Information Planning.

### a. General.

- (1) Due to the sensitivity and importance of information collection, analysis, and dissemination; all personnel engaged in civil disturbance operations must be familiar with and follow the policies of the Department of the Army.
- (2) At the national level, the Department of the Army relies upon the Department of Justice to provide:
  - (a) Civil disturbance threat information required for support planning throughout the Army for military civil disturbance needs.
  - (b) Early warning of civil disturbance situations which may exceed the capabilities for control by local and state authorities.
- (3) Army information resources are not used for the collection of civil disturbance information until the Department of the Army has made a determination that there is a distinct threat of civil disturbance beyond the capability of local and state authorities to control. Even after this determination has been made, the Army does not acquire, report, process, or store civil disturbance information on civilian individuals or organizations whose activities cannot, in a reasonable manner, be related to the distinct threat of a civil disturbance which may require the use of federal military forces (in accordance with AR 380-13).
- (4) When the Department of the Army or higher authority directs federal Soldiers to be placed on standby or be committed to help in restoring order, those troop elements involved are responsible (upon order) for processing civil disturbance data obtained by liaison personnel.
- (5) The production of data, when authorized, is accomplished under the supervision of the intelligence officer; however, the collection effort required is a coordinated and continuing one on the part of all concerned. The collection effort must be based on essential elements of data required for sound local planning and the conduct of operations. The collocation of command posts and the establishment of joint operation centers make the collection and exchange of information run smoothly. Rapid distribution of this data is vital to enable a quick and effective response by the task force.

### b. Collection.

- (1) Military information elements having counterintelligence resources will maintain the ability to collect civil disturbance threat data during the period in which there is a distinct threat of actual civil disorder requiring the use of federal military forces.
- (2) On activation by the Department of the Army, military intelligence elements having counterintelligence capability will:
  - (a) Establish and maintain contact with suitable local, state, and federal authorities.
  - (b) Collect civil disturbance data concerning incidents, and estimate the capability of civil authorities to control the situation. This can be achieved through direct contact with civil authorities.
  - (c) Report collection results to the Department of the Army in accordance with current plans.

- (d) Keep appropriate commanders informed.
  - (e) Provide intelligence support to the Personal Liaison Officer Chief of Staff of the Army.
  - (f) Recommend methods of overt collection, other than liaison, if required, to the Department of the Army for approval.
- (3) Military intelligence elements may employ methods of collection other than liaison only on order of the Department of the Army.
- (4) Covert agent operations are not used to obtain civil disturbance data on persons or organizations without specific advance approval of each operation by the Under Secretary of the Army.
- (5) Basically, the following vital elements of data will be required for sound planning and operations once approval has been received:
- (a) Objectives of elements which are a distinct threat to cause or are causing civil disturbances.
  - (b) Times and locations of disturbances.
  - (c) Cause of disturbances.
  - (d) Existence of persons, groups, or organizations which have distinctively threatened or are creating disturbances.
  - (e) Estimated number of persons who will be or are involved in civil disturbances.
  - (f) Assembly areas for crowds.
  - (g) Presence and location of known leaders and persons who are a distinct threat to cause civil disturbances.
  - (h) Organization and activities planned by the leaders who are a distinct threat to cause civil disturbance.
  - (i) Source, types and locations of arms, equipment, and supplies available to the leaders who are a distinct threat to cause civil disturbance.
  - (j) Use of sewers, storm drains, and other underground systems by the elements who are a distinct threat to cause or are causing civil disturbances.
  - (k) Identification of new techniques and equipment not previously used by elements that are a distinct threat to cause civil disturbances.
  - (l) Attitude of general masses towards:
    - (a) Groups causing civil disturbances.
    - (b) Civil law enforcement authorities.
    - (c) Federal intervention to control the disturbance.

(m) Possible threat to public property including private utilities.

(n) Communications and control methods employed by elements referred to in paragraph 1 above.

### PART C - Request for Federal Support/Training

#### 1. Request for Federal Support.

a. Providing military support to state and local governments to assist them in quelling a civil disturbance or riot requires close coordination through a host of state and federal agencies. It requires a thorough briefing of Soldiers at all levels on what they can and cannot do with respect to law enforcement. Civil authorities must be briefed on the restrictions placed on federal forces by the Constitution of the United States, federal statutes and laws.

b. Under the Constitution of the United States and United State Codes the President is empowered to direct federal intervention in civil disturbances to:

(1) Respond to state request for aid in restoring order

(2) Enforce the laws of the United States.

(3) Protect the civil rights of citizens

(4) Protect federal property and functions.

c. The Secretary of Defense retains approval for federal support to civil authorities involving the use of DOD forces, personnel, and equipment. The Secretary of the Army is the Department of Defense executive agent is the approval authority for federal emergency support in response to natural or man-made disasters (except weapons of mass destruction [WMD]). The Directorate of Military Support (DOMS) plans and executes the DOD domestic support mission to civil authorities. The DOMS is the DOD primary contact for all federal departments and agencies during DOD involvement in most domestic support operations. DOMS is also the staff agency responsible to the Chief of Staff, Army and Secretary of the Army for recommending to them appropriate measures necessary to cope with civil disturbances and terrorism and to transmit the approved recommendations to Department of Defense agencies for execution and to supervise the execution. The missions and functions of DOMS are outlined in AR 500-50. Additional roles of responsibilities of various agencies can be found in FM 3-19.15

Prior to activating federal military forces there is a sequence of steps that must occur. When data begins to show that a disturbance may develop into a situation that will require the help of federal forces, several actions are introduced at the federal level while state and local law enforcement agencies attempt to contain the disorder. Such actions may include increasing the readiness posture of forces named to help the jurisdiction concerned.

d. As the situation worsens and the state employs its National Guard, the U.S. Attorney General would send his personal agent to the scene of the disorder. This agent is named as the Senior Civilian Representative of the Attorney General (SCRAG) and is the organizer of all federal activities in the area of the disorder, including contact with local civil authorities. At the same time, the Chief of Staff of the U.S. Army would send his personal liaison officer (PLOCSA) to the scene along with members of the Department of the Army Liaison Team (DALT) that serves as his planning staff.

- e. At the same time the PLOCSA and DALT are sent, the Chief of Staff might order the task force commander with his key staff officers and unit commanders to the disturbed area for reconnaissance. These military personnel would try to blend in by wearing civilian clothing and using rental or police transportation.
- f. Should the disturbance continue to increase beyond local and state government capabilities, the state legislature or the governor would send a request to the President for help by federal Soldiers. The Attorney General of the United States has been named by the President to receive and organize requests from states for federal military aid.
- g. The task force commander and the PLOCSA would report their findings and recommendations to the Chief of Staff, U.S. Army, who in turn passes the data to the Secretary of Defense. The Senior Civilian Representative from the Attorney General, after consultation with the PLOCSA and the task force commander, makes his recommendation to the Attorney General. Following consultation with Department of Defense officials, the Attorney General, as an organizer of all federal civil disturbance activities, makes the recommendation to the President for using federal forces to help in restoring law and order.
- h. Before the President can send federal Soldiers, he must first issue a proclamation prepared by the Attorney General. The proclamation orders the crowd to leave the scene peaceably within a specified period of time. At any time during this sequence, the Attorney General may seek informal Presidential approval to pre-position federal Soldiers in the area of the disturbance. By policy, pre-positioning of less than a battalion does not require Presidential approval.
- i. The President's executive order triggers the employment of the task force; this move is fulfilled in a minimum amount of time as a result of sound planning and realistic training.
- j. With a letter of instruction as guidance, the task force commander will start operations to subdue the disturbance. The letter of instruction specifies command and control, rules of application of force, policy on custody and detention of civilians, limitations on searches, and required reports. The commander supports the local authorities but he does not take orders from them.
- k. After federal Soldiers are committed, the Department of the Army transmits to the state governor and others concerned, messages announcing the federalizing of Army and designated National Guard and Air National Guard units to active duty. These forces, once federalized, are placed under the command of the task force commander. Throughout the operation, the task force commander consults with the Senior Civilian Representative from the Attorney General regarding military operations and decisions, when feasible. He promptly advises the Chief of Staff, U.S. Army, on action taken as a result of the consultations. The Senior Civilian Representative from the Attorney General, in consultation with the task force commander, establishes and maintains liaison with civil authorities in the areas of operation and is the primary coordinator for all federal activities. After the disturbance has been reduced to the point that civil authorities are again capable of maintaining law and order, the decision to redeploy federal forces is made with the same care and coordination that took place prior to deployment. The announcement to redeploy will usually be made by the Secretary of the Army; the Chief of Staff, U.S. Army, will order federal forces back to home stations and the National Guard and Air National Guard will be returned to state control.

## 2. Training.

- a. The best made plans are of little value if the men carrying them out are not capable and well-trained. Therefore, all supervisors must ensure that each person is trained and equipped to handle the various tasks that he may be required to handle during a civil disturbance control mission. Civil disturbance training must be incorporated into the annual training program. The training must be intensive, realistic and sustained to

better prepare the Soldiers to perform the civil disturbance mission. A lack of individual training in civil disturbance operation may result in adverse effect to the point of endangering lives, especially the lives of Soldiers.

b. There are two basic areas of training to be considered in this lesson: individual training and unit/team training.

### 3. Individual Training.

a. Soldiers involved in civil disturbance duty require training to adjust themselves to the noise and confusion created by large numbers of people facing them. Countless other elements contribute greatly to anxieties and tensions. Individual Soldiers will be shouted at, insulted, shamed, belittled or called abusive names. They must learn to ignore these taunts and not allow personal feelings to interfere with the fulfillment of their mission. Any unauthorized actions taken against the demonstrator, may result in unfavorable publicity blaming the control force as using brutal tactics. Additionally, Soldiers can expect objects to be thrown at them, but must learn to avoid these objects; they must never throw objects back. Soldiers should understand that the well-disciplined fulfillment of orders is the most effective force applied against troublemakers. They must be instructed in all aspects of self-control so they may be mentally prepared for participation in civil disturbance operations.

#### b. Psychological influences.

(1) The action of civil disturbance participants and the general civil disturbance environment combine to impose strong pressure upon members of the control force. Just as the crowd may be swept into violence by such psychological influences as hoping to remain anonymous, the transference of moral responsibilities, and the release of deep set emotions, reactions of the control force may be improper because of the effect of such factors on them. Control force personnel must be made aware of these factors so they do not become victims of their influence. For instance: control force personnel at Kent State fired at a group of students. As far as can be determined, no one gave the order to fire and no one knows who fired first, but the actions of one or more persons were certainly imitated by other members of the control force.

(2) Civil disturbance operations and the emotional involvement and stress they create cause potentially dangerous situations which can lead to the excessive use of force by control force personnel. You must learn to expect the actions of civil disturbance participants and to operate in this stress environment. Above all, you must control your emotions and guard against excessive response and the urge to get revenge.

#### c. Unit Training.

(1) In the development of a unit training program for civil disturbance, many considerations should be addressed in term of resources that are available. An analysis of the units personnel, of who is trained and who is not, what Soldiers have real life experience and have graduated from the Non lethal Individual Weapons Instructor Course (INIWIC), type of equipment that is available, non lethal capabilities, times and locations to conduct training. Additionally you must look at incorporating the units SOP in civil disturbance (depending on your theater of operations, CONUS and OCUNUS).

(2) The Unit training program should utilize the seven step approach found in FM 7-0 and 7-1, and be based on the unit's METL, expected contingencies, prior training and the proficiency of the unit. The training program should not only cover the items described above but also cover all aspects of civil disturbance operations and should entail more than developing mechanical skill in crowd control

formations. Training should emphasize protection of fire-fighters, their equipment, residents of the area, use of non lethal weapons and tactics and other people trying to control the disturbance. Training should also include techniques of operations in those areas where you are most likely to be used, as well as procedures for neutralizing special threats.

(3) The purpose of training the units in civil disturbance training is to evaluate their capability to respond and carry out their assigned mission to quickly and deliberately execute the disturbance control procedures required to prevent loss of life and property and regain control; of a civil disturbance. Training should focus on, but is not limited to:

- (a) Instructors.
- (b) Individual and collective drills.
- (c) Leaders.
- (d) Equipment.
- (e) Weapons.
- (f) Munitions.
- (g) Live-fire range exercises.
- (h) Qualifications and familiarization.
- (i) Soldier training exercises (STXs)
- (j) Culminating exercises.

(4) Generally speaking, the basic unit training objectives are:

- (a) Unit training is designed to develop persons to function as a team. To be effective, this training must include all members of the unit.
- (b) Unit training must cover all aspects of civil disturbance operations. It must include more than developing mechanical skill in riot control formations.
- (c) Rehearsals of alert phases, loading plans, and operations plans should be held as often as deemed necessary to reach and keep the required degree of skill.
- (d) Integrated and concurrent training, stated in the appropriate ARTEPs should be included in unit training. Additional information on range set up and non-lethal training can be found in FM 3-19.15.

d. Weapons and Special Equipment. Personnel armed with special equipment must be well trained in its use. Examples of these special items may include the following: crowd control agent dispersers, non lethal weapons and munitions, grenade launcher, shotguns, sniper rifles, cameras, portable public address systems, night illumination devices, firefighting equipment, grappling hooks, ladders, ropes, armored personnel carriers, and roadblocks/barricades. It is important that every member of the control force be trained in using his assigned weapon and special equipment.

e. Special Procedures. There are numerous threats, such as sniping and bombing, which may be encountered during civil disturbance operations, which will require a specialized response to safely and effectively neutralize them. Experience shows the effectiveness of these countermeasures depends upon control and precision in execution. These in turn depend upon the quantity and quality of prior planning and proper training for handling such events.

f. Leadership. The conduct of civil disturbance operations places unusual demands on leadership skills. Control force supervisors should be made aware of these unusual demands and be prepared to cope with them. Therefore, training for civil disturbance operations should not be restricted to the Soldier. Commander and staff, at all levels, must examine their own experiences and degree of skill in these matters, to determine training required to reach operational readiness.

## PART D - Operational Techniques/Application of Force

### 1. Operational Techniques.

a. General. In assisting civil authorities in the restoration of law and order, military forces will be called upon to take action in a multitude of situations of varying magnitudes. The application of the principles discussed in this lesson will contribute in great measure to the successful accomplishment of a civil disturbance mission.

b. Minimum Force. The commitment of military forces to enforce civil law must be considered as a drastic last resort, and their involvement must be limited to that degree justified by necessity. In combat situations Soldiers are taught to fight and eliminate threats. In civil disturbance, Soldiers must deal with noncombatants that have internationally recognized rights. These rights must be respected while maintaining public order. The use of force must be restricted to the minimum degree consistent with mission fulfillment. The use of excessive or unnecessary force may subject the responsible person to civil or criminal liability and may serve to increase public sympathy for the demonstrators.

(1) The commitment of large numbers of Soldiers in a civil disturbance operation should not be misunderstood as the application of unnecessary force or the application of more than minimum force. Early and massive commitment of Soldiers has in the past prevented, in many instances, the worsening of a low-level civil disturbance into a violent confrontation.

(2) When actually committing forces in a civil disturbance operation, consideration must be given to the relative merits of deploying forces in maximum number on a "high visibility" or "low visibility" basis. There are advantages and disadvantages to both approaches; however, the determining factor should be the mood of the riotous element--the approach that is expected to produce the strongest deterrent effect upon their desire to commit further violence.

c. Operational Considerations. Military forces must be prepared for commitment in a civil disturbance role. An integral part of this readiness is the preparation of appropriate plans of operation. In developing these plans, commanders and staff must consider certain basic principles which are considered applicable to the execution of civil disturbance missions.

(1) Objective Area. The objective of military forces in civil disturbance control operations is the restoration of law and order within the area of operations. To fulfill this objective, the area of operations should be filled with well-disciplined, well-equipped, and well-trained Soldiers. Action must be taken



to hold back attempts by rioters to cause injury and damage to persons and property, and all persons succeeding in such acts of lawlessness apprehended and turned over to civil police.

(2) Positive Action. The successful application of the positive action principle depends to a great extent on getting correct data. Actions must be directed at defeating the overall purpose of the unruly element. They must be designed so that the commander is in the position of gaining and exercising the initiative with an ultimate objective of imposing his will upon the unruly group. Plans must be flexible enough that advantage can be taken of rapidly changing situations, while recognizing the requirement to be prepared to meet unexpected developments. When applying this principle, stick strongly to rules of engagement, standards of conduct, and fair treatment of civilians.

(3) Mass. Proper consideration should be given to the commitment of sufficient forces at the proper time and place. It is important in this regard, therefore, that forces prevent or subdue successfully and rapidly any and all acts of disorder and lawlessness. When forces are committed piecemeal and in inadequate numbers, they may not be able to cope with the situation. If successful in their acts, rioters will gain confidence and further acts of violence will be pursued, causing the disturbance to worsen. Vital to the proper application of the principle of mass is the need for good intelligence and close observation of the crowd and mob behavioral patterns. The most critical areas depend largely on the local situation and the reasons for the disturbance. In general, however, the business and industrial areas are most vulnerable to acts of violence.

(4) Economy of Force. This principle should not be considered as in conflict with the principle of mass. It should, instead, be considered as complementing the principle of mass. Skillful and discreet use of force will assist the control force to apply both principles with minimum outlay of resources. The key to applying both of these principles at the same time and successfully is the use of highly mobile, well-equipped reserve forces. Plans should call for the situation of the disturbance area with patrols equipped with non lethal capabilities to gather information and create the psychological impression of the control force being everywhere. However, the entire force should never be committed for this purpose. Patrol forces should be instructed to handle only acts of lawlessness which they are sure they can cope with and call for help in the more serious disturbances. Reserve forces should be strategically placed throughout the area and be capable of responding quickly to these calls for help.

(5) Maneuver. Proper maneuver is vital in gaining and maintaining the advantage. In a civil disturbance operation, the object of maneuver is to employ force in such a manner as to give them the advantage and thus achieve results which are least costly in men and material. This involves the selection of patrol areas and the control of critical routes to ensure freedom of movement. It also involves the choice of key terrain where a crowd may be more easily controlled. Finally, military forces should be able to move easily to help them reach the scene of any disturbance quickly.

(6) Unity of Command. Unity of command assures unity of effort by the action of all forces toward the common goal of restoring law and order. While unity of command is best achieved by vesting, a single commander with the required authority to fulfill tasks that must be done, it is not always possible. Because of legal sanctions, local, state, and federal forces cannot be united under one commander in civil disturbance operations. Federal military forces to include the National Guard when federalized will not fall under the control of any local or state agency. Therefore the establishment of joint operations centers, and the recognition of each other's capabilities and limitations, will create a positive attitude and will contribute to unit of effort.

## 2. Application of Force.

### a. General.

(1) Civil disturbance operations by federal forces will not be authorized until the President is advised by the highest officials of the state that the situation cannot be controlled with nonfederal resources available. The mission of the control force is to help restore law and order and to help maintain it until such time as state and local forces can control the situation without federal help. In performing this mission, the control force may have to actively participate, not only in subduing the disturbance, but also in helping to detain those responsible for it. Control force commanders are authorized and directed to provide such active participation, subject to restraints on the use of force.

(2) Prior to committing any federal forces in the quailing of civil disturbance whether in CONUS or OCONUS commanders should train and continually brief the control force on the rule of engagement (ROE). The commander is responsible for drafting, interpreting, disseminating, and training the control force on the ROE. The staff Judge Advocate (SJA) should be included in the ROE development to ensure that it will not improperly constrain actions, but still will remain consistent with domestic and international laws, polices, and orders of the chain of command.

(3) If non lethal weapon and munitions are to be utilized, they should be addressed within the ROE and disseminated to the lowest level, preferable to platoon and squad levels. This requires that all personnel have a clear understanding of the ROE and the commander's intent.

(4) While serving with a multinational operation under the preview of the United Nations (UN) charter or customary international law the UN will may mandate certain restrictions on the use of force. By the use of overwhelming force during a civil disturbance under the UN may compromise diplomatic efforts to reach a peaceful solution. Commanders must beware that any confrontation of the ROE made by soldiers can have strategic political implications on current and future operations.

(5) The primary rule which governs the actions of federal forces in helping state and local authorities to restore law and order is that the control force use only the minimum force required fulfilling the mission. This chief principle should control both the selection of appropriate operational techniques and the choice of options for arming the control force. In carrying out this principle, the use of deadly force is authorized only under extreme circumstances where certain specific standards are met. To emphasize limitations on use of firepower and to restrict automatic fire, rifles with only a safe or semiautomatic selection capability or modified to such a capability will be used as a basic weapon for Soldiers in a civil disturbance area.

(6) By utilizing the scalable effects concept in response to a gathering crowd or demonstration, the use of force policy must be clearly understood by the soldiers or control force that they may only use the minimum amount of force to quell the situation without the graduated response, which may cause a escalation of hostilities or violence. Commanders should consider using the following scalable effects process:

(a) Try to persuade the crowd to quietly disperse by talking to the leaders of the demonstration.

(b) Use translators as necessary.

(c) Let the first approach to the leaders or demonstrator by the local or state authorities (governor, mayor or law enforcement personnel).

(d) Pass out handbills requesting that the crowd return home.

(e) Use video tale and still cameras to photograph individuals and events for later use in trails.

(f) Give warning before moving to the next level of force.

(7) All personnel, prior to participation in civil disturbance operations, need to be trained and briefed as to:

(a) The specific mission of the unit.

(b) Rules of engagement and use of force governing the application of military force as they apply to the specific situation.

(c) A psychological orientation on the local situation, specifically addressing types of abuse which military personnel may be expected to receive and the proper response to these types of abuse.

b. Use of Deadly and Non-deadly Force.

(1) Commanders are authorized to use non-deadly force to control the disturbance, to prevent crimes, and to detain persons who have committed crimes; but the degree of force used must be not greater than that reasonably necessary under the circumstances. The use of deadly force, in effect, invokes the power of summary execution and can, therefore, be justified only by extreme circumstances. Accordingly, its use is not authorized for the purpose of preventing activities which do not pose a significant risk of death or serious bodily harm. If a mission cannot be accomplished without the use of deadly force, but deadly force is not permitted under the guidelines authorizing its use, accomplishment of the mission must be delayed until sufficient non-deadly force can be brought to bear. All the requirements of paragraph (b), below, must be met in every case in which deadly force is employed.

(2) The use of deadly force is authorized only under conditions of extreme necessity and as a last resort when all lesser means have failed or cannot be reasonably be employed. Deadly force is justified under one or more of the following circumstances:

(a) Self- defense and defense of others. When deadly force reasonably appears to be necessary to protect law enforcement or security personnel who reasonably believe themselves or others to be in imminent danger of death or serious bodily harm.

(b) Assets involving national security. When deadly force reasonably appears necessary to prevent the actual theft or sabotage of assets vital to national security. DoD assets shall be specifically designated as “vital to national security” only when their loss, damage, or compromise would seriously jeopardize the fulfillment of a national defense mission. Examples include nuclear weapons; nuclear command, control, and communications facilities; and designated restricted area as containing strategic operational assets, sensitive codes, or special access programs.

(c) Assets no involving national security but inherently dangerous to others. When deadly force reasonably appears to be necessary to prevent the actual theft or sabotage of resources, such as operable weapons or ammunition, that are inherently dangerous to others; i.e., assets that, in the hands of an unauthorized individual, present a substantial potential danger of death or serious bodily harm to others. Examples include high risk portable and lethal missiles, rockets, arms, ammunition, explosives, chemical agents, and special nuclear material.

(d) Serious offenses against persons. When deadly force reasonably appears necessary to prevent the commission of a serious offense involving violence and threatening death or serious bodily harm. Examples include murder, armed robbery, and aggravated assault.

(e) Arrest or apprehension. When deadly force reasonably appears to be necessary to arrest, apprehend, or prevent the escape of a person who, there is probably cause to believe, has committed an offense of the nature in (2) through (4) above.

(f) Escapes. When deadly force has been specifically authorized by the Heads of the DoD Components and reasonable appears to be necessary to prevent the escape of a prisoner, provided law enforcement or security personnel have probable cause to believe that the escaping prisoner poses a threat of serious bodily harm either to security personnel or others.

(3) Every Soldier has the right under the law to use reasonably necessary force to defend himself against violent and dangerous personal attack. The limitations of this paragraph are not intended to infringe on this right, but to prevent the unauthorized or random use of other types of deadly force.

(4) In addition, the following policies regarding the use of deadly force will be observed:

(a) Give an order to halt.

(b) Warning shot will not be fired.

(c) When a firearm is discharged it will be fired with the intent of rendering the person(s) at whom it is discharged incapable of continuing that activity or course of behavior prompting the individual to shoot.

(d) Shot will be fired only with due regard for the safety of innocent bystanders.

(e) In the case of holstered weapons, a weapon should not be removed from the holster unless there is reasonable expectation that use of the weapon may be necessary.

(5) Even when its use is authorized, deadly force must be used only with great selectivity and precision against the particular threat which justifies its use. For example, the receipt of sniper fire, however deadly, from an unknown location can never justify "returning the fire" against any or all persons who may be visible on the street or in nearby buildings. Such random response is far too likely to result in accidents among innocent bystanders or fellow law enforcement personnel; the appropriate response is to take cover and try to locate the source of the fire so that the threat can be neutralized.

(6) Task force commanders are authorized to have live ammunition issued to personnel under their command. The individual Soldier will be instructed, however, that he may not load his weapon except when authorized by an officer, or provided he is not under the direct control and supervision of an officer, when the situation would justify the use of deadly force. Keeping control over the loading of weapons until such time as the need for such action is clearly established is of critical importance in stopping the unjustified use of deadly force. When possible, command and control arrangements should be specifically designed to facilitate such careful control of deadly weapons.

(7) The presence of loaded weapons in tense situations may invite the application of deadly force in response to being annoyed which, while subject to criticism, is not sufficient to justify its use; and increases the danger that the improper discharge of a weapon by one or more persons will lead others to a reflex response on the mistaken assumption that an order to fire has been given. Officers should be clearly instructed, therefore, that they have a personal obligation to withhold permission for loading until circumstances show a high probability that deadly force will probably be necessary and justified under

the guidelines previously discussed. Strong command must be exercised to assure that the loading of weapons is not authorized in a routine, premature, or blanket manner.

(8) Positive control over weapons must be exercised at all times. Individual Soldiers will be instructed that they may not fire their weapons except when authorized by an officer, or provided he is not under the direct control and supervision of an officer, when circumstances would justify the use of deadly force. He must not only be thoroughly familiar with the rules for use of deadly force, but he must also realize that whenever his unit is operating under the immediate control of an officer, that officer will determine whether the firing of live ammunition is necessary.

c. Command and Control.

(1) The chain of command and areas of responsibility must be clearly defined at all levels. Whenever practicable, the assigned unit boundaries should coincide with the local police subdivisions to simplify coordination of activities in the area. Boundaries are usually located in streets or alleys with coordinating points at street intersections. When a street is named as a boundary, responsibility for both sides of the street is given to one unit to ensure proper coverage. Arrangement should be made to have civil police and Soldiers operate together. In addition to the joint action by police and Soldiers in the streets, arrangements should be made to exchange liaison officers at each headquarters from company through division on a 24-hour basis. Arrangements should also be made for the collocation of military and civilian police command elements.

(2) A written copy of special orders must be given to Soldiers upon their arrival on the scene. These orders, along with the restrictions in effect for the operations, must be understood and complied with by all Soldiers. The populace must be treated fairly in all cases. Any incident of unnecessary property damage or bodily harm will create anger which may result in increased acts of violence.

(3) Commanders at all levels should ensure that the Soldiers establish the immediate impression that they are well-disciplined, well-trained, and fully ready to fulfill their mission. This initial impression must then be maintained throughout the operation. Appearance is extremely important and the Soldiers should wear Kevlar helmets, web gear, and carry weapons at all times when outside buildings. Rest areas should not be located near assigned posts in public view. The psychological impact on the civilian populace of being faced by an alert, well-disciplined military force effectively deters some potential rioters and looters. Soldiers assigned to stationary posts and motorized or foot patrols should be relieved from those duties often since alertness fades quickly in this type of duty.

(4) To ensure that the Soldiers remain alert and observe the orders and instructions in effect, it is important that commanders at all levels get on the ground with the Soldiers to supervise their activities and to provide guidance in questionable cases. Having the commander on the ground with Soldiers is also an important morale factor and strengthens the Soldier's sense of accomplishment.

d. Apprehension.

(1) The apprehension of an individual lawbreaker or groups of violators is a vital function during civil disturbance operations. Because of the legal considerations involved, civil police should be used to make the actual apprehension whenever possible. When military forces detain or take a civilian in to temporary custody, he will be turned over to civil police as soon as possible.

(2) Military personnel should be instructed not to ask questions at the scene. No questions should be asked of the suspect other than identification inquiries such as name, place of residence, or place of

employment. Questioning pertaining to the incident could create legal complications which might prevent a subsequent conviction.

(3) Personnel must promptly report to their superiors, follow-up in writing all important data concerning the detention of civilians, including the names and locations of witnesses. DD 2708, Receipt for Inmate or Detained Person, may be used for this purpose. Photographs taken at the scene and attached to the report are very valuable for identification purposes and for later use in court testimony. The report should be retained at the appropriate headquarters, and used as a basis for preparing a report to the civil police. Any physical evidence obtained, together with evidence tags and receipts completed as required, will be delivered with the detained person.

(4) Violators must be treated fairly and impartially. Minimum force necessary should always be a guiding principle. Consideration must be given to the safety of innocent bystanders, the seriousness of the incident, and the weapons of the violators. Attitudes and commands are especially important. An offender may respond to firm statements regarding the disadvantage to him of further action. If the desired response is obtained, the apprehension or detention should be made using clear and concise commands with the exercise of due caution and vigilance.

e. Handling and Processing of Detainees.

(1) It is important that military commanders give special consideration to the proper procedures in handling detainees even though this problem normally is the primary concern of civil authorities. The large numbers of offenders which may be apprehended or detained in an area of civil disorder poses a special problem for disturbance control forces. If time permits, prior formal arrangements concerning details of handling civilians taken into custody should be made; if this cannot be done, arrangements should be formalized at the earliest possible time.

(2) Detainees should be quickly processed and removed from the scene of the arrest. This procedure should include a quick search, out of sight of onlookers, if possible. They should then be separated prior to removal from the area. The separation is based on the amount of custody needed to secure the detainee, sex, and age. Injured prisoners must be removed to medical facilities. Female personnel must be provided to search female detainees. It is especially important that names and addresses of witnesses be recorded by apprehending or detaining personnel.

f. Army Detention Facilities.

(1) The Army will not operate facilities for confinement, custody, or detention of civilian personnel apprehended for violation of local or state laws as long as civil confinement facilities, operated by the Department of Justice, state, or local agencies are sufficient to accommodate the number of persons apprehended.

(2) When it appears that available local facilities are insufficient, due to the large number of persons apprehended or detained, and this fact can be verified by the person or agency responsible for the facilities, temporary confinement/detention facilities may be operated with prior approval from DA, specifically, the Chief of Staff, U.S. Army. These facilities will be operated only until custody of the persons detained can be transferred to and assumed by civil authorities. They will not be used for the confinement of persons charged or convicted under civil jurisdiction.

(3) Temporary confinement/detention facilities can be developed from local federal facilities provided they are adaptable to the requirements of custody and control. Such facilities should be established, if possible, within the affected area; this will conserve time, transportation, and escort personnel.

However, if no suitable federal property is available within the affected area, they can be located elsewhere on any property under federal control as long as the persons to be detained are apprehended in the affected area. Whenever such temporary facilities are established during civil disturbance control operations, the Army is responsible for providing those personnel, facilities, and supplies necessary for the custody, control, health, comfort, and sustenance of persons detained.

(4) Officers and key NCOs specifically trained and experienced in confinement operations are required to operate such facilities. Guards and support function personnel operating under the direct control of such officers and NCOs need not be specifically trained or experienced in confinement operations as long as they are under close and continuing supervision of trained responsible personnel. Whenever females are detained, they must be held in physically separate detention facilities and under the control of selected female guards operating under the supervision of trained and experienced confinement personnel.

(5) Temporary detention facilities should be constructed and arranged to provide for adequate custody, control, and safety of detainees. It is advisable to use existing permanent-type buildings. Where sufficient permanent structures are not available, only that amount of new construction required for temporary custody, control, and administration of prisoners should be accomplished. Temporary field-type facilities provide compartments to assure effective control.

(6) The same operational procedures that apply to the operation of installation confinement facilities and treatment of detainees apply to these temporary facilities except that those policies and procedures establishing training, employment, mail and correspondence, and administrative discipline requirements will not apply. Detailed guidance in procedures for confinement of detainees is contained in EPW Operations, FM 3-19.40.

g. Special Equipment. Certain items of equipment available to military and civil police forces can do much to limit injuries to civilian and military personnel and destruction of property. These items increase the psychological effects of a show of force and offer additional protection and versatility to civil disturbance forces during the operations.

(1) The 12 gage shotgun is a pump action shotgun currently in the non lethal capabilities set (NLCS) inventory. The pump action shotgun is chambered to take up to 3-inch shells. The 3-inch chamber allows for the use of M1012 and M1013 NL munitions. This shotgun also provides a visually distinct alternative to standard military weapons that may be desired based on mission considerations.

(2) The shotgun, as in the case of other firearms used in civil disturbance operations, is fired only on the orders of a qualified superior officer when lesser measures of force are not effective, or when the individual Soldier has no other means of protecting his life.

(3) The M7 is a 66-millimeter vehicle-mounted NL grenade-launching device that is mounted on a HMMWV. It is an indirect fire support system that can deliver the M99 blunt trauma grenade that creates a sting-ball effect. The M315 installation kit is used to install an M7 discharger on the turret ring of appropriate HMMWV variants. An adjustable bracket allows the launch angle to be depressed for engaging targets at ranges of 50, 75 and 100 meters. The system enforces standoff distances and deters potential threats.

(4) The M1012 is a single projectile round made of hard rubber that is shaped like a bomblet and designed to be fired at a single target. With the muzzle velocity of 500 feet per second, the M1012 has an effective range of no closer than 5 meters and no further than 30 meters. Engagement inside of 5 meters could result in serious bodily injury or death. Beyond 30 meters the kinetic energy dissipates to the

point where the round becomes ineffective.

(5) The M1013 is a multiple projectile round with .23 caliber hard rubber pellets that is designed to be fired at and employed with the purpose of affecting multiple targets. With a muzzle velocity of 900 feet per second, the M1013 has an effective range of no closer than 5 meters and no further than 30 meters. Engagements of less than 5 meters can result in seriously bodily injury or death. Beyond 30 meters the kinetic dissipates to the point where the round becomes ineffective

(6) The midsize riot control disperser (M37) is the size of a standard fire extinguisher that uses compressed air to force the RCA out to a range of 30 feet. It has the capacity to employ 18 bursts of RCA into a hostile crowd while maintaining excellent standoff capabilities. The M37 can be refilled and is rechargeable. It can be refilled with CR solution (liquid agent) or CS (dry agent). For the purpose of training the M37 can be filled with water and CS can be substituted with talcum powder.

(7) The Squad riot control agent disperser (M33A1) is designed to provide crowd control and protection at the squad level. It is capable of projecting a ballistic stream of RCA's beyond 25 feet in up to 25 half-second bursts. It consists of a frame and harness assembly, compressed-gas cylinder (agent container assembly) air pressure assembly, gun and hose assembly, multi-jet spray unit, and check valve assembly. The M33A1 can be refilled and is rechargeable. For training purposes, CR can be substituted with water and CS and be substituted with talcum powder.

(8) The above mentioned items are but just a few of the non-lethal weapons and munitions available to the commander and unit to utilize during a response to the civil disturbance, and can be utilized to train and prepare Soldiers. Additional non-lethal weapons and munitions as well as protective gear can be found in FM 3-19.15.

3. Vehicles. Armored vehicles and transport vehicles add to the readiness of the crowd control force. The use of these vehicles increases flexibility, reduces troop commitments, and provides protection for personnel. In considering the use of vehicles, however, it must be remembered that they should be secured by foot elements.

a. Armored Security Vehicles (ASV) can be used in several ways to keep the effects of civil disturbances at a minimum.

(1) Their use adds a considerable psychological effect to riot control formations while providing added protection for Soldiers. They provide a readily accessible barrier for Soldiers to crouch behind if necessary, and excellent protection for those inside.

(2) Their use as mobile command posts offers the added advantages of security, communication, and mobility.

(3) They are well adaptable to roadblock operations providing the advantages listed above, while at the same time providing an excellent barrier.

(4) Their use for patrolling an area of violence adds to the psychological effect, and allows Soldiers to maneuver in close to snipers in order to make an apprehension.

b. Standard military transport vehicles can be modified with sandbags, armor plating, wire screening, or similar materials to give some protection against sniper fire and thrown objects. They provide mobility and communication capability for area coverage. Soldiers should be deployed with ample vehicles to provide sufficient flexibility to handle all situations in an area of civil disturbance. TOE allowances should probably be increased for this purpose.



3. Other Equipment. In addition to the special equipment discussed above, certain other items should be available for use in operations within the disturbance area.

- a. Armored vests and protective masks are required for anti-sniping operations and at other times when violence is expected. Flexibility is an important consideration. For example, the limitation on visibility must be considered when requiring the use of protective masks, and the limitation on mobility when wearing the armored vests.
- b. Successful conduct of the overall operation may depend on other items. Auxiliary lighting should be available to include hand-portable lights, vehicular-mounted searchlights, spotlights, flood-lights, flashlights, flares (with caution toward fires), and vehicle headlights. Prefabricated wood or metal barriers, or suitable materials, such as wire or ropes, may be used to block off an area; signs should be provided to supplement these barriers. Evidence equipment, including movie and still cameras with telescopic lenses, and recording devices should be obtained and placed into position.
- c. Other items of equipment should also be provided. Helicopters should be used for observation, communication relay, illumination, resupply, reserve displacement, and numerous other tasks. Adequate firefighting and fire protection equipment are vital in civil disturbance.
- d. Provisions should be made for appropriate communications equipment for use at the scene and between the scene and the operations headquarters. Every available means of communications to include public address systems--both hand-portable and vehicle-mounted--should be used.

#### PART E - Operational Tasks

1. General. In any civil disturbance operation, certain tasks must be accomplished to reach the ultimate objective of restoring and maintaining law and order. To do this, action must be taken to gain control of the situation. Control forces must perform certain tasks that will develop a physical and psychological environment which will permit law enforcement personnel to enforce the law and maintain order. The importance of having a high degree of flexibility and selectivity in the response cannot be overemphasized. It is just as important that the tasks selected be completed only after a careful evaluation of the situation. This evaluation must consider the particular uniqueness of the situation. In this respect, the commander selects those tasks that are most likely to reduce the intensity of the given situation. Therefore, not all tasks will apply in all situations, but control force commanders and unit leaders must identify those tasks which must be performed and then develop plans and procedures for their accomplishment. The operational and integrated tasks listed below are discussed in detail in the paragraphs and lessons to follow.

- a. Operational Tasks.
  - (1) Isolate the area.
  - (2) Secure likely targets.
  - (3) Control crowds or mobs.
  - (4) Establish area control.
  - (5) Neutralize special threats.
- b. Integrated Tasks.

- (1) Gather, record, and report information.
- (2) Apprehend violators.
- (3) Maintain communications.
- (4) Maintain mobile reserves.
- (5) Inform the public.
- (6) Protect the fire service operations.
- (7) Process detained personnel.

## 2. Isolate the Area.

a. This task includes the restriction and sealing off of the disturbed area. The objectives of sealing off the disturbed area are to prevent the disorder from spreading to unaffected areas, to prevent escape of persons bent on expanding the disturbance, to speed up the exit of the uninvolved, and to exclude unauthorized personnel from entering the affected area. In order to prevent the disturbance from expanding in size and strength, it is critical to prevent the inflow of extra demonstrators or curious onlookers into the disturbed area.

b. When military forces are committed to helping the civil authorities in controlling civil disturbances, the situation will be beyond the capability of local law enforcement agencies and a scene of major disorder should be expected. This disorder may be characterized by small, dispersed groups which are looting, burning, and generally causing havoc in the area, or it may be characterized by large groups participating in varying degrees of illegal conduct. The initial action taken by military forces to control the disorder is critical and should include the immediate isolation of the disturbed area.

c. The initial commitment of control force personnel may be required to clear a building or an area in order to isolate the persons creating the disturbance from those not yet motivated or actively involved. The primary emphasis should be on identifying what area and who has to be isolated.

## 3. Isolated Techniques. There are several techniques to use when isolating a disturbed area.

a. Barricades and Roadblocks. Barricades and roadblocks are physical barriers which deny or limit entry into and exit from the disturbed area. They can be used to totally deny passage of people and vehicles or to permit certain designated categories of persons and vehicles to pass. They must be positioned so as to prevent their being bypassed, surrounded, or cut off from support. In many cases, it may be impractical to physically seal an area due to the physical and geographical considerations, such as in the case of a college campus or a suburban area.

b. Barricades Against Personnel. Civil disturbance operations contingency planning should provide for the availability of portable barricades which slow down the passage of personnel. Concertina wire is a suitable material for rapid construction and effectiveness, although wooden sawhorses, ropes, and other field expedient devices may suffice. Concertina wire should be used sparingly and only under serious circumstances as it is indicative of violent disorders.

c. Roadblocks Against Vehicles. The erection of effective roadblocks which cannot be easily breached by vehicles requires large, heavy construction materials. One item that can be stockpiled in advance is 55-gallon drums to be filled with water or earth on site. Other materials include sandbags, earthworks, trees, or heavy vehicles. Several roadblocks placed at intervals of 25 to 50 feet provide sufficient depth to prevent breaches by heavy or high-speed vehicles.

d. Construction Considerations. The construction of barricades and roadblocks should provide cover from small arms fire where this threat is likely. Provisions should be for night illumination of approaches to the position; however, care must be taken not to silhouette the personnel manning it. Construction materials which would chip or shatter upon impact by thrown objects should be covered with canvas or sandbags to prevent injuries from flying fragments. Warning signs should be placed in front of the position directing authorized personnel not to approach the position. One technique of providing a quickly erected barrier is the use of vehicles parked bumper to bumper; however, this procedure may subject the vehicles to damage by a hostile crowd. Another device which may be effectively used both as a barricade and a part of a formation is the use of a locally built frame of wood or metal with wire covering.

e. Perimeter Patrols. Perimeter patrols should be established to prevent entry or exit from the disturbed area, particularly by persons or groups trying to bypass barricades and roadblocks. These patrols operate along the outer operational boundary of the disturbed area. Perimeter patrols can be integrated with area patrol routes within the disturbed area.

f. Pass and Identification Systems. Unit, installation, or municipal contingency planning should include a pass and identification system providing for the entry and exit of authorized personnel to and from the isolated area. Procedures should be established for press personnel, emergency medical personnel, public utility work crews, and for any other personnel who have a legitimate purpose for entering and exiting the isolated area. Consideration must be given to those persons residing within the disturbed area who must travel to and from work. An effective pass and identification system requires careful and detailed planning as a contingency measure.

g. Public Utility Control. Ensure that civil authorities have established a means for controlling public utilities to include street lights, gas, electric, water, and telephone services so that they may be turned on or off to support the tactics employed by the control forces.

#### 4. Secure Likely Targets.

a. General. Certain buildings, utilities, and services are critical to the economic and physical well-being of a community and require security to prevent disruption of essential functions. In addition, certain facilities and buildings have become symbolic targets to radical or extremist elements and should be identified and afforded protection with the priorities established. Among the likely targets to be attacked are control force command posts, billeting areas, and motor parks. Another potential problem in civil disturbance operations is the threat posed by dissident elements intent on doing bodily harm to control force personnel and civilian dignitaries in the disturbed area. When such threats exist, military personnel may have to be committed to security operations. In particular, security must be placed on armories, arsenals, hardware, and sporting good stores, pawnshops, and gunsmith establishments, or other places where weapons or ammunition are stored. To conserve manpower, consideration may be given to evacuating sensitive items, such as weapons from stores and storing them in a central facility. Priorities for physical security must be established to prevent waste of available forces on less important facilities or those which have their own physical security forces. The degree of security necessary to protect various buildings and utilities is determined by considering the following:

(1) The importance of the facility to the overall well-being of the installation or community. Examples of this consideration include the loss of water or electrical power which would endanger the health of the community, the destruction of government buildings which would disrupt the functioning of government, and dissident capture of communications media which would provide a psychological advantage for further spread of the disorder.

(2) The vulnerability of the facility to acts of violence. Planning should estimate the possible degree of risk expected during a civil disturbance based on the facility's physical layout, type construction, and existing protective measures.

(3) The intent and capability of the demonstrators. This consideration is an analysis of the destructive intent and capability of dissident elements. This includes determining likely targets and the degree of violence such activity will likely entail.

b. Security Techniques. The techniques for securing likely targets consists of providing physical control, the procedures for which can be found in FM 19-30, Physical Security. Military forces are ideally organized and equipped to perform this task; security of government buildings and public utility facilities is a normal mission for military forces in most types of civil disturbances. This releases civil police to operate within the disturbed area in their law enforcement capacity. Security techniques used to fulfill this task fall into two broad categories as discussed below.

(1) Use of Personnel. This category includes employment of sentinels, walking guards, and checkpoints. Military personnel used in this manner should be committed jointly with existing guard forces from the protected facility or agency. Consideration should be given to the possibility of increasing existing guard forces capability with additional equipment. When manning fixed security posts, guard teams must be of sufficient size to fulfill their mission and protect themselves until help arrives; however, availability of reserve forces in lieu of stationary guards should be considered in an effort to conserve guard forces.

(2) Use of Material. This category includes use of perimeter barriers, protective lighting and alarm systems, and intrusion detection devices. These are designed to deter and detect intruders and/or to slow down access to a facility by unauthorized personnel. Various measures of this type may or may not be in effect at the time of the civil disturbance. Military emergency planning should anticipate the requirement for the quick employment of additional physical security measures.

## 5. Building/Area Searches.

a. General. The conduct of a building/area search can be a hard and dangerous operation, especially when searching for a sniper. Whenever possible, searches should be performed by a special reaction team which has been trained and equipped for such an operation.

b. The command element of the team should establish a central location for coordination of all elements. Communications should be established and maintained with the force securing the area and with observation posts.

c. Deployment of Security Element. The security element should be positioned on the immediate perimeter of the area or building to observe any activity and all exits. The security element should also establish a preferred route of entry in to the building or area.

d. Preparation for the action element prior to their entry into the area or building should include the following:

- (1) A briefing on the area of building through the use of maps, drawings, and knowledgeable residents.
  - (2) Equipment and communications checks.
  - (3) The issuance of an operations order.
- e. Commit the Action Element to the Area or Building. When committing the action element to an open area, crowd control agents should be used to saturate the area prior to entry. The action element should enter the area on one side of the perimeter established by the cover element and then proceed through the area towards the other side of the perimeter. When committing the action element to a building, the following methods of entry can be utilized.
- (1) Enter at the top when possible.
  - (2) If entry at the bottom is necessary, an armored personnel carrier should be used.
- f. Whenever a search is conducted, whether of a building or an area, it must be done systematically.
- (1) In an open area, the action element should maneuver and search under the protection of cover, firing only when necessary to protect life and property. Either the security or action element may use crowd control agents to aid the advance of the action element. The security element on the opposite side should remain in position as the noose closes. The purpose here is to force the sniper or other dissidents to withdraw making themselves vulnerable to capture by the security element. The techniques used for neutralizing dissidents/snipers in an open area will require close coordination and communication between all elements involved.
  - (2) In an apparent unoccupied building the military working dog (MWD) should be used whenever possible. A well-trained MWD with its highly developed sense of smell can pinpoint the location of a dissident/sniper quickly and with a minimum of risk to members of the search force. When the MWD is not available, each room should be searched by at least a two-man team. One may throw a crowd control agent grenade in, wait for it to discharge, then enter quickly and place his back against the nearest wall. The second person follows and searches the room in detail. If available, a third person remains in the corridor to ensure that the suspect does not move from room to room while the two others are conducting their search. The action element leader should be kept informed of the team's progress. When using riot control agents to help in the clearing of a building, grenades of the non-burning type should be used to avoid the possibility of fire.
  - (3) In an occupied building, when the dissident's/sniper's location is unknown, all suspected rooms must be searched. The action element should try to have occupants submit voluntarily to the search of their rooms. At the same time, occupants should be questioned in an attempt to pinpoint the sniper's location. If occupants will not submit voluntarily and there is probable cause to believe that the dissident/ sniper is located in the room, a complete physical search of the room or rooms should be conducted. Use of the patrol dog will help in conducting such searches.
  - (4) In a building occupied or not, where the dissident's/ sniper's location is known, the action element should proceed directly to the immediate area of that location. If the dissident/sniper refuses to exit voluntarily, crowd control agent grenades should be thrown or projected into the room from the outside by the security forces. If this is not practical, the door should be opened or broken down and crowd control agent grenades thrown into the room. If crowd control agents cannot be used, the patrol dog in

his attack role can again be effectively used in subduing and capturing the dissident/sniper with a minimum of risk to the search element.

## SUMMARY

During the course of this lesson you have learned that if your personnel are not trained or adequate plans have not been made, your control forces cannot be relied upon to react properly. Civil disturbances cannot be predicted as to the exact time or place they will occur, but, you can assist the commander with the planning considerations necessary to manage and effectively control these disorders.

### Lesson 1 Test

The following questions are multiple choices and/or true/false. You are to select the one that is correct. Show your choice by CIRCLING the letter beside the correct choice directly up the page. This is a self-graded lesson exercise. Do not look up the correct answer from the lesson solution sheet until you have finished. To do so will endanger your ability to learn this material. Also, your final examination score will tend to be lower than if you had not followed this recommendation.

1. When developing plans for use of Military Forces in a civil Disturbance role, which of the following IS NOT an operational consideration?
  - A. Psychological influences.
  - B. Mass.
  - C. Economy of force.
  - D. Maneuver.
  
1. A military unit preparing for Civil Disturbance missions passes through two general phases. These phases are:
  - A. Logistical and alert.
  - B. Alert and operational.
  - C. Planning/training and alert.
  - D. Planning/training and operational.
  
1. When selecting bivouac or billeting for the Soldiers during a civil disorder, which of the following should be considered?
  - A. They should be located far away from the disturbed areas to minimize the stress placed on the demonstrators.
  - B. Only one route to and from the disturbed area is necessary.
  - C. Communications facilities should be restricted to avoid rumors which could be picked up by the media.
  - D. Use federal, state, or public property in order to prevent excessive claims for property damages.
  
1. When involved in individual training, the Soldier should be subjected to:
  - A. Excessive crowd noise.
  - B. Quiet demonstrators.
  - C. Brutality.
  - D. Impersonality.
  
1. When military personnel apprehend a suspect during a civil disturbance, any questions should be limited to:
  - A. Questions pertaining to the incident.
  - B. Questions about other demonstrators.

- C. Questions about future demonstrations.
  - D. Questions about their identification.
1. For proper development of decentralized control, clearly defined duties should be assigned to the lowest possible level.
    - A. True.
    - B. False.
  2. The mission of military forces during civil disturbances, both in CONUS and OCONUS, which cannot be overly emphasized, is to help local and state authorities to restore and maintain law and order.
    - A. True.
    - B. False.
  1. Officers and key NCOs specifically trained and experienced in confinement operations are not required to operate temporary detention facilities.
    - A. True.
    - B. False.
  9. What two items can be utilized with the shotgun?
    - A. M7 66-millimeter projectile with M315 installation kit.
    - B. M1012 single projectile and M1013 multiple projectile.
    - C. M33A1 and M37 riot control dispenser.
    - D. 40 millimeter projectile with M774 installation kit.
  10. Who retains the approval for federal support to civil authorities involving the use of DOD forces, personnel and equipment?
    - A. Director of Military Support
    - B. Defense Coordinating Officer
    - C. Secretary of Defense
    - D. State Coordinating Officer

## EXERCISE SOLUTIONS

### ANSWER KEY AND FEEDBACK

<u>Item</u>	<u>Correct Answer and Feedback</u>
1.	A. Psychological influences. (page 1-18)
2.	C. Planning/training and alert. (page 1-4)
3.	D. Use federal, state, or public property in order to... (page 1-10)
4.	A. Excessive noise. (page 1-15)
5.	D. Make identification inquires. (page 1-24)
6.	A. True. (page 1-6)
7.	A. True. (page 1-4)
8.	B. False. (page 1-25)

9. B M1012 single projectile and M1013 multiple projectile (page 1-25)
10. C The Secretary of Defense. (page 1-14)

## LESSON 2

### CROWD CONTROL TECHNIQUES

#### OVERVIEW

##### LESSON DESCRIPTION:

In this lesson you will learn to use crowd control techniques and supervise immediate action to be taken upon contact with an explosive device.

##### TERMINAL LEARNING OBJECTIVE:

**ACTION:** Use crowd control techniques and react to a explosive device.

**CONDITION:** You will have this subcourse.

**STANDARD:** To demonstrate competency of this task, you must achieve a score of 70 percent on the subcourse examination.

**REFERENCES:** The material contained in this lesson was derived from the following publication: FM 3-19.15; FM 3-19.10; FM 3-19.4.

#### INTRODUCTION

Confrontation management operations will require control forces which can effectively confront a variety of crowds and mobs. Fast, effective crowd control is vital in every type of civil disturbance. Of equal importance is the maintenance of crowd control once order has been established.

#### PART A - CROWD CONTROL

##### 1. Control.

a. Manner of Control. A suitable manner of controlling various types of crowds will be influenced by many variables. These include:

- (1) The current strength level of the civil disturbance.
- (2) Public opinion.
- (3) Current policies.



- (4) Crowd mood, intent, composition, and activity.
- (5) Capabilities and readiness of control forces.
- (6) Immediate and long-range benefits of control force action.
- (7) Weather, terrain, and time of day.

b. Crowd Control Options. In today peace keeping and peace enforcement environment the use of firearms may not be the viable solution when US military forces are faced with separating two belligerent, hostile ethnic groups or preventing the spread of civil unrest. Crowd control options are often combined. Consideration of the variables listed above will show the control force commander the general nature of the most suitable manner of controlling a particular crowd. Four crowd control options are available to the commander, based on his objective with a particular crowd. These options are available to provide the commander the flexibility of action. In order to advance this flexibility, there are numerous techniques available from which the commander may select and employ in various combinations. The commander has the capability of selectively tailoring his response for whatever crowd situation with which he is confronted. A prime consideration in selecting an option or options will be the effect of the response on reducing the strength of the existing situation. The four crowd control options are listed below.

(1) Monitoring. This option consists of watching the crowd's progress and development by control force teams. Monitoring helps the commander to gauge the crowd's activity and intent in relation to the larger civil disturbance and possibly to influence the crowd through persuasive means. Monitoring is a continuous task that will last through out the duration of the demonstration, and can provide the commander with vital information that would help defuse a situation and prevent it from escalating beyond what it should have or cause a response to be inadequate based on the situation.

The commander may task observation team to monitor crowd activities to gather information.

They report on the size, location, mood, and developing situations. The observation team can consist of a marksman, a radio operator, and an observer with binoculars. The team must provide timely information back to the commander so he may influence the outcome of a situation with simple negotiations. Monitoring is particularly suitable for large, nonviolent demonstrations where more decisive action is not possible because of crowd size or where the strength of the situation would increase. This option is also suitable as a temporary measure pending the arrival of additional control forces. Techniques for fulfilling this option include passive observation of the crowd and the communication of interest and intent to leaders.

(2) Disperse. This option consists of action taken to fragment a crowd and is especially applicable to small crowd situations in a congested urban environment. Its selection should include the consideration that such dispersion may increase and spread lawlessness rather than reduce it. Therefore, the commander should establish control over the routes of dispersal, and area or areas into which he plans to disperse the crowd; provide security for those facilities which might become likely targets for small groups; and be prepared to follow up the dispersal operation with the apprehension of small groups still active in the area. Techniques for fulfilling this option would include the proclamation, show of force, use of crowd control formations, and use of crowd control agents.

(3) Containing. This option consists of restraining a large number of persons within the area that they are presently occupying, thereby containing any further aggressive activity. This option would be suitable in a college campus situation, to prevent demonstrations from spreading out to surrounding

communities, and to prevent unauthorized personnel from entering the campus. Containment would also be the suitable option where the systematic apprehension of crowd members is considered. Crowd control formations, perimeter patrols, and barriers are effective methods to accomplish containment. In all instances, caution must be used to avoid "fight-or-flight" syndrome common to people feeling trapped with no escape.

Armored vehicles, armored security vehicles (ASVs), and up-armored HMMWVs are adaptable to roadblock operations as they can serve as barriers, as well as protect Soldiers inside and outside the manning of roadblocks, by giving the Soldiers something to crouch behind if objects are thrown.

(4) Blocking. This option consists of the physical denial of a crowd's advance upon a facility or area which is the potential or actual target of dissident activity. Crowd control formations, principally the line and barricades, are the most appropriate techniques for this option. Barricades, such as vehicles, concertina wire, and water-filled barrels can be erected to block or channelize the movement of the crowd. These devices, when used in combination with Soldiers and other crowd control techniques, are useful in accomplishing the options of containment or blocking.

c. Techniques for Crowd Control. There are numerous techniques designed to provide the commander with flexibility of action in accomplishing crowd control. He must select a combination which will produce the desired results within the framework of the selected crowd control option. The most common techniques appropriate for military usage are discussed below.

(1) Observation. This consists of deployment of persons or teams to the periphery of a crowd for the purpose of monitoring its activity. It includes gathering data on crowd size, location, mood, and reporting on the developing situation. This technique includes posting persons on strategic rooftops and other high terrain overlooking the crowd. This latter measure provides additional security to control force personnel should they become committed to other crowd control operations. Such a team may be composed of an expert marksman, a radio operator, and an observer equipped with binoculars. Care must be taken to assure that committed control forces are aware of the locations of such teams to prevent their being mistaken for sniper elements.

(2) Communication of Interest and Intent. In certain situations, effective communication with crowd and mob leaders and participants may enable the commander to control the situation without resorting to more severe actions. When planned and organized demonstrations, marches, or rallies within the disturbed area are announced, the control force commander in coordination with local authorities should meet with organizers of the activity in order to communicate the interest of the control forces. The following matters, as appropriate, should be discussed.

- (a) Parade or demonstration permits.
- (b) Location of demonstration and routes of march.
- (c) Time limits for the activity.
- (d) Provision of marshals by activity organizers.
- (e) Prevention of violence.
- (f) Safety of all concerned.

(3) The task force commander and local authorities should also communicate to the activity organizers

their intent to cope with violence, unlawful actions, and violations of restrictions imposed on the activity. It is intended that, by this communication between activity organizers and control force personnel, the demonstration, rally, or parade will occur without incident through the mutual cooperation of all concerned. The intentions of control forces will not be effective if delivered as an ultimatum. A limited, begrudging dialogue with activity organizers reduces the opportunity for authorities to learn the plans of the demonstrators. It must be remembered that if this communication is not effected, the activity organizers might well hold the demonstration in defiance of local authorities, thereby creating a potential for violence that might not have existed if this technique had been employed.

d. Channelization. Pressure can be brought to bear on the dissident leadership to channel the crowd into an area which will minimize the disruption when the following requirements are met:

- (1) When communications have been established with the dissident leadership.
- (2) When the intent and nature of the crowd activity is known.

e. Diversion. When communication exists with the dissident leadership, consideration may be given to efforts to divert the leadership of the crowd itself from its stated or obvious objective. The diversion should support the objectives of the control force either by reducing the strength of the crowd situation or motivating the crowd to seek an area more easily controlled by the control force.

f. Cooperation. Decreasing the potential disruption of the crowd activity may be accomplished by an active attempt on the part of the control force to obtain cooperation of the dissident leadership. Whenever there is an attempt by the crowd leadership to seek permission and cooperation of the local government, every effort should be made to maximize this cooperation by demonstrating an attitude of facilitation. This may be accomplished by helping the leadership to organize a peaceful demonstration while establishing guidelines which will minimize the impact of the demonstration on the community.

g. Selection of Force Options.

(1) The commitment of federal military forces must be viewed as a drastic last resort. Their role, therefore, should never be greater than is absolutely necessary under the particular circumstances which exist. This does not mean, however, that the number of Soldiers used should be minimized. The degree of force required to control a disorder is often inversely proportionate to the number of available personnel. Doubts concerning the number of Soldiers required should normally be resolved in favor of large numbers since the presence of such large numbers may prevent the development of situations in which the use of deadly force is necessary. A large reserve of Soldiers should be maintained during civil disturbance operations. The knowledge that a large reserve force is available builds morale among military and law enforcement personnel and helps to prevent overreaction to annoying acts by unruly persons.

(2) In selecting an operational approach to a civil disturbance situation, the commander and his staff must follow the "minimum necessary force" principle; for example, crowd control formations or crowd control agents should not be used if the area filled with manpower would be sufficient.

(3) Every effort should be made to avoid appearing as an alien invading force and to present the image of a restrained and well-disciplined force whose sole purpose is to help to restore law and order with a minimum loss of life and property and due respect for those citizens whose involvement may be purely accidental. Further, while crowd control personnel should be visible, tactical, or force concentrations which might tend to excite rather than to calm should be avoided where possible.

(4) The normal reflex action of the well-trained combat Soldier to sniper fire is to respond with all firepower available. In a civil disturbance, this tactic endangers innocent people more than snipers. The preferred tactic is to allow a special reaction team (SRT) who is trained for this type of mission, to enter the building from which sniper fire starts. Keeping with the controlling principle that the team must use only the minimum force necessary to fulfill the mission, the commander may select any one of the following options for arming his Soldiers:

(a) Riot Shield. In the hands of a well trained soldier, the riot shield can be utilized as both a defensive and offensive weapon when contact is made with an aggressive crowd. The primary use of the riot shield is for defense of the line. However, each riot shield holder must be proficient in its retention. The Soldier holding the shield must be trained to react when a demonstrator grabs the top of the shield by slapping with his strong hand and gives the following command "Get back", "Get away" "Stop". If a rioter grabs the bottom of the shield the Soldier should be trained in forcefully dropping to one knee and pinning the rioters' fingers to the ground.

(b) Baton. The baton is most effective in a crowd control operation and is considered the primary weapon for crowd control operations. The baton is considered to be an offensive weapon with reduced lethality and unlike the rifle, the loss of a baton to the crowd does not create a serious threat. Soldier must be trained with the riot baton to the point its various techniques are automatic to them. This training must also include the vulnerable points on the body so they can avoid areas that may cause permanent injury or death when struck.

Currently there are two types of riot batons, wooden and expandable. The most common one is the 36 inch hickory riot baton with thong. There is also the 24-inch to 36 inch expandable riot baton, which has been added to the nonlethal capabilities set. Each Soldier within the control force need to be proficiently trained in all techniques for blocking and striking. Improper use of the riot baton by an untrained Soldier has the potential for creating a greater problem than what already exist.

(c) Shotgun. The 12 gage shotgun is a pump action shotgun currently in the nonlethal capabilities set (NLCS) inventory. The pump action shotgun is chambered to take up to 3-inch shells. The 3-inch chamber allows for the use of M1012 and M1013 NL munitions. This shotgun also provides a visually distinct alternative to the standard military issues weapon.

(d) Rifle. The rifle, if capable of automatic fire, must be modified to prevent automatic operation. Keeping with the controlling principle of using only the minimum force necessary to fulfill the mission. If the Soldier are equipped with their long weapons and are in the front lines of the formation, the weapon should be carried across their back from left to right with the muzzle of the weapon pointed down and the butt of the weapon pointed up. The weapon should be cleared and the magazine in the proper ammunition pouch.

(e) Non lethal weapons and munitions. Nonlethal weapons and munitions are an additional asset afforded to the commander in civil disturbance and are preferred over lethal force. The showing of force with nonlethal weapons and munitions may assist in crowd dispersing, separate, or leave the area with minimal casualties. This nonlethal capability set (NLCS) is a well-rounded, versatile package of both equipment and munitions. NLCS are divided into four distinct categories: personnel protection, personnel effectors, mission enhancers and training devices

(f) While each of the above options represents an escalation in the level of force, they are not sequential in the sense that a commander must initially select the first option, or proceed from one to another in any particular order. So long as the option selected is appropriate, considering the

existing threat, the minimum necessary force principle is not violated.

1. The rifle and rifle with bayonet attached have extremely limited offensive use as both may constitute deadly force. The primary value of the rifle or the rifle with bayonet attached is the psychological impact on the crowd. While the use of fixed bayonets can add considerably to this effect, the danger of intentional or accidental injury to demonstrators or fellow control force personnel prevents such use except with extremely violent crowds.
2. Fire by selected marksmen. Fire by selected marksmen may be necessary under certain circumstances. Marksmen should be pre-selected, trained, and thoroughly instructed. They may be placed on vehicles, in buildings, or elsewhere as required.
3. Full firepower. The most severe measure of force that can be applied by Soldiers is that of available unit firepower with the intent of producing extensive casualties. This extreme measure would be used as a last resort only after all other measures have failed or obviously would be impractical, and the consequence of failure to completely subdue the crowd would be an imminent overthrow of the government, continued mass casualties, or similar grievous conditions.

4. Shotgun. The riot shotgun is an extremely versatile weapon; its appearance and capability also produce a strong psychological effect on rioters. It is particularly suited to certain applications in civil disturbance operations. When used with No. 00 buckshot ammunition, it is an excellent point target weapon extremely effective at limited range. By varying the nonlethal munitions' M1012 and M1013 the weapon can be employed with considerably less possibility of serious injury or death. This provides the commander with a desirable flexibility in selecting the ammunition most appropriate under the existing conditions

(g) The measures described in paragraphs 1 through 5 below, may be applied in any order as deemed suitable by the responsible commander as long as his application is consonant with prescribed confrontation management techniques outlined earlier.

(1) Proclamation. A public announcement is considered an excellent medium to make known to a crowd the intentions of the control force commander. In some cases, such an announcement makes further action unnecessary. An announcement puts the population on notice that the situation demands extraordinary military measures, prepares the people to accept military presence, tends to inspire respect from lawless elements and supports law-abiding elements, gives psychological aid to the military forces trying to restore order, and shows to all concerned the gravity with which the situation is viewed. In making a proclamation, a commander may consider imposing a time limit. However, the situation may change, and not imposing a time limit may leave the commander other options as he sees fit, as long as the proclamation is specific in its instruction.

(2) Show of Force. A show of force is effective in various situations in civil disorder control operations. A show of force may as simple as Soldier dismounting from buses or trucks in plain sight of the demonstrators, but must be far enough away to prevent a provoked attack of thrown objects. When a crowd has gathered in a large area, show of force can take the form of marching a well-equipped, highly disciplined control force into their midst. When persons are scattered throughout the disturbance area in small groups, a show of force may take the form of motor marches of Soldiers throughout the area, saturation patrolling, and the manning of static posts or similar measures.

(3) Employment of Crowd Control Formations. Crowd control formations are used to contain,

disperse, block or break up a non conforming crowd; these crowd control formations are more effective in urban areas than they are in open fields or parks. When this method is utilized in urban areas, it is easy to disperse or split the crowd into small groups, isolate instigators, or funnel a crowd into a desired area. The use of such formations is part of the show of force and has a strong psychological effect on any crowd.

(4) Employment of Water. Water from a high pressure hose may be effective in moving small groups on a narrow front such as a street or in defending a barricade or roadblock. Personnel applying water should be protected by riflemen and in some cases by shields. In the use of water, the factors discuss below should be considered.

(a) Water may be used as a flat trajectory weapon utilizing pressure, or as a high trajectory weapon using water as a rainfall. The latter is highly effective during cold weather.

(b) The use of a large water tank (750 to 1,000 gallons) and a power water pump mounted on a truck with a high pressure hose and nozzle capable of searching and traversing will enable Soldiers to use water as they advance. By having at least two such water trucks, one can be held in reserve for use when required.

(c) In using water, as with other measures of force, certain restraints must be applied. Using water on innocent bystanders, such as women and children, should be avoided; ways to escape must be provided; and the more severe use, flat trajectory application, should be used only when absolutely necessary.

(d) Fire departments are normally associated with lifesaving practices rather than maintenance of law and order. In order to maintain this image, fire department equipment will not be used for riot control and crowd dispersal.

(e) Use of Crowd Control Agents. Crowd control agents are extremely useful in civil disorder control operations because they offer a humane and effective method of reducing resistance and lessen requirements for the application of more severe measures of force. Task force commanders are authorized to delegate the authority to use crowd control agents and other forms of non lethal force at their discretion.

## 2. Establish Area Control.

a. General. Acts of violence, such as looting, arson, and vandalism, are greatly reduced when the physical and psychological influence of lawlessness is defeated. In establishing effective area control, commanders must recognize the problem of widespread looting and arson that has accompanied most large urban disorders. Performance of this task consists of reducing or eliminating those conditions which contribute to the outbreak or continuation of lawlessness in the disturbed area.

(1) Looting. When dealing with persons involved in looting, extreme care and adherence to the principle of minimum force must be observed. Looting may start at any time or place as an isolated incident and spread quickly throughout the affected areas. Looting is not limited to any particular sex or age group; it includes the very old, the very young, women, and children. For example, many children may be looting without any idea of how serious their actions are. In the control of looting, unit leaders must recognize that deadly force is not authorized.

(2) Anti-looting. Unit commanders must be familiar with anti-looting measures which can be taken by civil authorities, such as boarding up broken or unbroken windows, covering windows with photo-

luminescent particles, and by the prompt posting of looting penalty proclamations. Anti-looting actions that can be taken by military forces include the establishment of foot and motor patrols, the posting of fixed guard posts, and the lighting of likely areas for looting. Guards at fixed posts will be briefed not to leave their posts to pursue individual looters on foot, but to remain on post and prevent looters from approaching their areas of responsibility. All guards must be briefed that looters will not be fired upon nor will deadly force be used to catch looters.

(3) Protected or Sensitive Commercial Establishments. A main consideration in the conduct of civil disturbance operations is to prevent liquor, drugs, weapons, and ammunition from falling into the hands of rioters. Therefore, liquor stores, drug stores, sporting good shops, pawn shops, and hardware stores are main targets for looters and must be kept under close observation by means of foot and motorized patrols. Normally, businesses of this type must be identified in advance and included in emergency plans.

(4) Arson. Arson is generally defined as a crime of purposely setting fire to a building or property. Acts of setting fire to buildings, property, etc., often follow disturbances. Certain situations may arise in controlling arson where the use of deadly force is authorized and necessary.

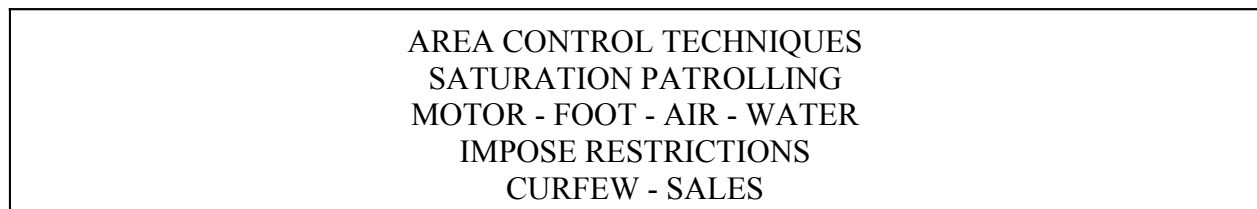

FIGURE 2-1 AREA CONTROL TECHNIQUES.

b. Area Control Techniques. The techniques (see figure 2-1) most suited to the task of area control include the following:

(1) Saturation Patrolling. Alert, aggressive patrolling deters the assembly of crowds, provides data on the developing situation, and creates a psychological impression that the control force is everywhere. Patrols are particularly valuable in preventing overt arson and for prompt reporting of fires and other violence. Whenever possible, patrols should be used with existing civil police patrols to concentrate forces and provide for a military/civilian communication capability. This gives the Soldiers the advantage of early area familiarity and provides civil police aid to the military patrol members. Patrol routes for mounted and dismounted patrols should be varied, both as to patterns and times, to prevent snipers, arsonists, and looters from being able to select a safe time to conduct their activities. Patrol members must stick to proper standards of conduct and fair treatment of civilians at all times; they must realize that they are performing an important community relations function as well as a control function. Depending upon the nature and location of the civil disorder, several types of patrols can be used effectively.

(a) Motor Patrols. Because of their speed and mobility, motor patrols are able to provide the commander with timely ground reconnaissance, provide extended enforcement coverage, and respond to calls for aid from other patrols and guard posts. Radio communication should be maintained with the control force headquarters. Motor patrols may be used to make periodic contacts with foot patrols and stationary posts which may lack communication means. All motor patrols should be equipped with fire extinguishers with which they may put out small fires, thereby preventing larger fires and reducing the necessity for calling the fire department. The vehicle should be modified with sandbags, wire screens, or similar materials to protect against sniper fire or thrown objects. Motorized patrols should consist of three vehicles with three personnel per vehicle.

(b) Foot Patrols. Depending upon the degree of violence and extent of activity in the patrolled area, foot patrols may range from two- to four- or six-man elements or squad-size units. Foot patrols are more useful in areas where the population movement is heavy and/or the area to be patrolled is small. Foot patrols must be able to protect themselves and control a limited number of disorderly persons.

(c) Air Patrols. Air patrols can perform reconnaissance and surveillance missions over the disturbed area. They are an excellent means of providing timely data on the actions of dissidents, extent of damage, status of access routes, location and condition of road barriers, and other important data. They can help the commander in the direction of the overall control effort within the disturbed area.

(d) Water Patrols. Water patrols can be used where the disturbed area contains or is bordered by navigable water. Water patrols function in a similar manner to motor patrols.

(2) Imposed Restrictions. Except in the unlikely event of martial law, federal military forces will not have the authority to impose restrictions such as a curfew on the civilian population. Certain restrictions, however, may be imposed by civilian authorities to help in the control of lawlessness. Military leaders should be prepared to recommend which restrictions are of substantial value in comparison with the burden of enforcement. The most commonly used restrictions include:

Curfew. The curfew is a control measure which has proved highly effective in many civil disturbances. Its purpose is to restrict the unauthorized movement of personnel on streets and public places during specified periods of time, especially during the hours of darkness. Joint planning with civil authorities regarding the imposition of a curfew should provide for:

(a) Coordination of the initiation, enforcement, and termination of a curfew.

(b) Public announcements of the beginning and ending of curfews. Civilian authorities make these announcements through local mass media, pamphlets, and public address systems to ensure maximum exposure.

(c) Curfew exemptions and guidance on who should receive them, including written authorization or passes.

(d) Provision for the apprehension and disposition of curfew violators.

(3) Sales Restrictions. Restrictions on the sale, transfer, and possession of sensitive material such as gasoline, firearms, ammunition, and explosives will help control forces in minimizing certain forms of violence. Limiting the availability of weapons to the potential sniper or terrorist may reduce the likelihood of such violence. The effective enforcement of these restrictions, however, requires extensive planning and the commitment of adequate manpower to this effort.

## PART B - Neutralization of Special Threats

1. General. Lessons learned from past civil disturbances show that control forces will be frequently exposed to special threats which pose grave danger to both the control force and to the general community. Special threats include such acts as bombing and sniping. Three general steps are required to neutralize all special threats.

a. Take immediate action. The first concern is the person or the control force unit or team encountering a special threat, such as sniping, is personal safety and safety of others in immediate danger. Individual soldiers and control force leaders should be trained and rehearsed on the immediate action to be taken upon



encountering sniping, a bomb threat, or an explosive device. The immediate action step specifically avoids hastily attempted, disorganized, responses that will likely further danger the control force and the public.

b. Secure the area. Before the identified threat can be effectively neutralized, the danger area must be secured. The control force unit or team on the scene or reinforcements should be used to isolate the area to stop the escape of perpetrators and to prevent the influx of unauthorized personnel from the control force and from the general public. In addition, the entire area may have to be cleared of persons endangered by the threat. In the case of sniping, if evacuation of personnel from the danger area is not possible, warnings to seek cover should be issued using public address communications.

c. Employ special teams. Poorly trained and equipped control force personnel should not try to destroy a threat. Operations requiring the removal of a sniper from a barricaded position or the removal of an explosive device should be performed by selected teams of specially trained, specially equipped personnel. Explosive ordnance disposal (EOD) units should be used to destroy explosive devices.

2. Bombs. During civil disturbances, control forces should be trained to recognize fire bombs, pipe bombs, and other devices. They should also be trained and rehearsed in the immediate action necessary when discovering an explosive device. The actual destruction of the bomb should be accomplished by the EOD unit or civil police bomb unit. Two specific steps (See Figure 2-2) are required when an explosive device is found:

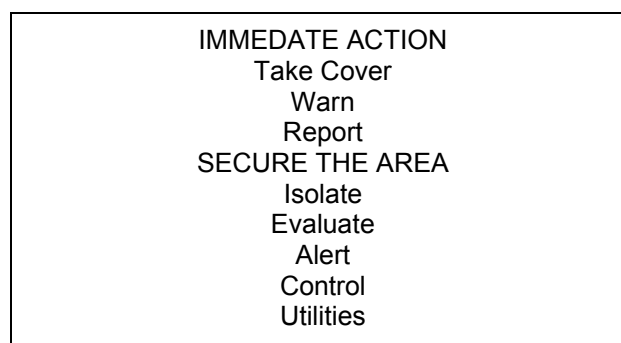

FIGURE 2-2. STEPS TO TAKE WHEN AN EXPLOSIVE DEVICE IS ENCOUNTERED.

a. Immediate Action. The individual soldier or control force unit or team that discovers an explosive device should:

- (1) Take Cover. All personnel should immediately leave the area and seek cover wherever possible.
- (2) Warn. Notify all personnel to clear the area.
- (3) Report. Inform the appropriate personnel of the situation so that aid can be sent to the scene.

**NOTE: DO NOT, AT ANY TIME, HANDLE THE DEVICE.**

b. Secure the Area. After the individual soldier or control force unit or team has taken the immediate action, steps should be taken to secure the area. If the control force unit or team is capable, they may be used to secure the area. The senior member of the element responsible for securing the area should consider the following:

- (1) Isolate. Establish roadblocks or checkpoints as necessary to keep unauthorized personnel out of the area.

(2) Evacuate. Ensure that all personnel are out of the danger area.

(3) Alert. Notify fire, local police bomb squad, (if not available notify the military EOD), and medical personnel and direct them to a staging area for quick deployment.

(4) Control Utilities. The close down of all gas, electric, and water service to the affected area should be accomplished by qualified personnel familiar with the utilities and the area.

c. After the area has been secured, the EOD unit or civil police bomb unit should be escorted to the location of the device. The actual destruction and disposal of the explosive device should be accomplished by an EOD unit or civil police bomb unit.

d. Bomb Threats. Bomb threats may increase during civil disturbances or during other times of tensions and crises. Frequently, warning calls or notice have been given when an explosive device has been actually planted to avoid loss of innocent lives. However, on occasion, cranks, deranged persons, or disgruntled employee may make threats or give fake notice following an actual explosion to cause activity or business to stop by forcing evacuation. If a prank call is successful in causing evacuation, more threats will follow. Safety must always be resolved in favor of evacuation. Most bomb threats are received by telephone operators in industry and educational facilities. It might also be expected that bomb threats will be received at rumor centers, police headquarters, and joint operational facilities during civil disorders. If possible, each facility should be provided with a telephone tracing capability. Telephone switchboard operators and others likely to receive bomb threats should be trained to accomplish the following:

e. Activate the telephone tracer system.

f. The person receiving the phone call may be the only person to have a conversation with the person who has knowledge of the explosive device. Therefore it is extremely important that the receiver of the call records or writes down the conversation word for word so that no important information is forgotten or missed. By writing down the exact wording or electronically recording the conversation, and utilizing FBI Form 6-136 (Bomb Threat Checklist) the person receiving the call can ask specific questions from the caller such as:

(1) Bomb location.

(2) Time of explosion.

(3) What will cause the bomb to explode?

(4) Type of device, to include physical description.

(5) Sex, approximate age, and attitude of caller.

(6) Strange speech, accent, etc.

(7) Distinguishing sounds or background noises coming from the caller's location.

(8) Reason for the bomb placement.

**NOTE: See Figures 2-3 for front and back of the FBI Bomb Data Sheet.**

- g. Inform the appropriate personnel of the threat (EOD or local police bomb unit).
- h. Actions Upon Receipt of Bomb Threat. Upon receipt of a bomb threat, the responsible commander should accomplish the following:
- (1) Alert. Notify the necessary control force elements, civil law enforcement or military police, fire and medical service personnel, utilities personnel (water, gas, and electricity), and civil police bomb squads or military EOD units and direct them to report to a staging area near the threatened facility.
  - (2) Isolate. Establish roadblocks or checkpoints as necessary to keep unauthorized personnel out of the area. Isolation should take place at a safe distance from the area to prevent danger from an explosion.
  - (3) Evacuate. The senior occupant of the building makes the decision to evacuate. Control forces may only make a recommendation to evacuate. If the decision is made to leave, it should be done in an orderly fashion using a bomb evacuating plan, a fire plan, or appropriate announcements and directions to building occupants. Such a plan should name a building or area which provides shelter from the elements. Care must be taken not to create panic. Before leaving the building, occupants should check their immediate locations for any unusual or out-of-place objects or packages. Employees should be advised to take their briefcases, overcoats, and like items with them as they leave.
  - (4) Organize Search Elements. Selected occupants of the building (familiar with its layout) and control force personnel should be organized into search elements. They should not be equipped with hand held radios, instead if they need to communicate with each other or personnel outside the danger area, they should utilize one of the following methods:
    - (a) Voice.
    - (b) Runners.
    - (c) Whistles.
    - (d) Field phones.
    - (e) Hand signals (if one point is visible by all)

**CAUTION: THE USE OF RADIOS DURING THE SEARCH CAN BE DANGEROUS. THE RADIO TRANSMISSION ENERGY CAN CAUSE AN EARLY EXPLOSION OF AN ELECTRIC INITIATOR (BLASTING CAP).**

- (5) There are two types of searches that can be conducted, a supervisor search or a search team search.
  - (a) Supervisors Search: A supervisor search can be conducted by the supervisor and a few volunteers that are familiar with the overall layout of the building and can be conducted without the building being evacuated, by utilizing a quick-pace method to look for suspicious items. This search can be useful only if the areas are well organized and not cluttered.
  - (b) Search Team Search: A search team search requires that the building be evacuated until after the search has been completed. The team should consist of two personnel who volunteer and are assigned to familiar with the area they are searching. It must be stressed that they know if an object

is supposed to be there or not. For this reason, law enforcement and EOD should not conduct the initial search of the building.

(6) Searches should be made of public access areas such as utility areas, hallways, administrative areas, mess areas, outside of buildings, shipping or loading areas, vehicles parked near the facility, supply rooms, under stairwells, and accessible closets and storage areas. Suspicious objects or packages found during the search should be reported. They should not be handled. Even when a bomb is located, the search should continue since there may have been more than one bomb.

i. Whenever the bomb itself or a suspicious object or package is found, the EOD or civil police unit should be notified and used to destroy the bomb or suspect package. Further guidance in this subject area will be found in FM 19-10.

j. Arson is not usually the first of the special threats to happen. Arson itself is reasonably easy to handle in that fires can be seen and their size is readily definable. The following measures will help the control force in stopping arson, arresting arsonists, and limiting the damage resulting from both acts of arson and accidental fires.

(1) Preventive measures include convincing local members of the importance of security. This consists of selling them on the importance of creating a security atmosphere through the installation of lighting, alarms, gates, and other measures. Once a disorder has started, increased surveillance, through saturation patrolling, and stationary guard posts, and isolation of the affected area by the use of barricades and roadblocks will help in controlling arson. Patrols are especially effective in preventing overt arson, in giving notification of the location of fires and conducting spot checks of persons acting in a suspicious manner or searching for materials and devices used to set fires. Roadblocks and barricades reduce the movement of persons in the affected area and also provide an opportunity for searches of suspicious persons for materials and devices needed for arson. Control force commanders may find it helpful to develop lists of known and suspected arsonists from the files of civil law enforcement agencies and distribute this data to all control force personnel. Consideration should be given to forming specially trained teams or arson experts such as specialists from police, fire and insurance agencies to investigate promptly all acts of suspected arson and attempted arson and to help control forces at the scene of arson incidents.

**EXAMPLE OF A BOMB THREAT CHECKLIST**

6-136 (Rev. 8-27-77)



**FBI BOMB DATA CENTER**

PLACE THIS CARD UNDER YOUR TELEPHONE

**QUESTIONS TO ASK:**

1. When is bomb going to explode?
2. Where is it right now?
3. What does it look like?
4. What kind of bomb is it?
5. What will cause it to explode?
6. Did you place the bomb?
7. Why?
8. What is your address?
9. What is your name?

**EXACT WORDING OF THE THREAT:**

\_\_\_\_\_

\_\_\_\_\_

\_\_\_\_\_

\_\_\_\_\_

\_\_\_\_\_

\_\_\_\_\_

\_\_\_\_\_

Sex of caller: \_\_\_\_\_ Race: \_\_\_\_\_

Age: \_\_\_\_\_ Length of call: \_\_\_\_\_

Number at which call is received: \_\_\_\_\_

Time: \_\_\_\_\_ Date: \_\_\_\_/\_\_\_\_/\_\_\_\_ FB-002

**BOMB THREAT**

**CALLER'S VOICE:**

<input type="checkbox"/> Calm	<input type="checkbox"/> Nasal
<input type="checkbox"/> Angry	<input type="checkbox"/> Stutter
<input type="checkbox"/> Excited	<input type="checkbox"/> Lisp
<input type="checkbox"/> Slow	<input type="checkbox"/> Raspy
<input type="checkbox"/> Rapid	<input type="checkbox"/> Deep
<input type="checkbox"/> Soft	<input type="checkbox"/> Ragged
<input type="checkbox"/> Loud	<input type="checkbox"/> Clearing throat
<input type="checkbox"/> Laughter	<input type="checkbox"/> Deep breathing
<input type="checkbox"/> Crying	<input type="checkbox"/> Cracking voice
<input type="checkbox"/> Normal	<input type="checkbox"/> Disguised
<input type="checkbox"/> Distinct	<input type="checkbox"/> Accent
<input type="checkbox"/> Slurred	<input type="checkbox"/> Familiar
	<input type="checkbox"/> Whispered

If voice is familiar, who did it sound like?

\_\_\_\_\_

\_\_\_\_\_

**BACKGROUND SOUNDS:**

<input type="checkbox"/> Street noises	<input type="checkbox"/> Factory machinery
<input type="checkbox"/> Crockery	<input type="checkbox"/> Animal noises
<input type="checkbox"/> Voices	<input type="checkbox"/> Clear
<input type="checkbox"/> PA System	<input type="checkbox"/> Static
<input type="checkbox"/> Music	<input type="checkbox"/> Local
<input type="checkbox"/> House noises	<input type="checkbox"/> Long distance
<input type="checkbox"/> Motor	<input type="checkbox"/> Booth
<input type="checkbox"/> Office machinery	<input type="checkbox"/> Other _____

**THREAT LANGUAGE:**

<input type="checkbox"/> Well spoken (educated)	<input type="checkbox"/> Incoherent
<input type="checkbox"/> Foul	<input type="checkbox"/> Taped
<input type="checkbox"/> Irrational	<input type="checkbox"/> Message read by threat maker

**REMARKS:** \_\_\_\_\_

**Report call immediately to:**

\_\_\_\_\_

Phone number \_\_\_\_\_

\_\_\_\_\_

Date \_\_\_\_/\_\_\_\_/\_\_\_\_

Name \_\_\_\_\_

Position \_\_\_\_\_

Phone number \_\_\_\_\_

FIGURE 2-3. FBI BOMB DATA SHEET.

(2) The use of deadly force may be required to prevent acts of arson which would cause loss of human life or destruction of facilities vital to public safety. However, only the minimum necessary force should be used, and commanders are required to carefully weigh all alternatives and ensure that all other means have been expended or are not feasible prior to authorizing the use of deadly force.

(3) Some general methods for controlling the use of accelerants as starting devices for fires are as follows:

- (a) Solicit active cooperation of vendors of various types of flammable liquids.

- (b) Provide police protection to stations selling fuel in the disturbed area.
- (c) Limit sale of gas in portable containers to 5 gallons.
- (d) Protect gasoline supply in service stations abandoned because of civil disorders.
- (e) Station auxiliary police in unattended fire stations.

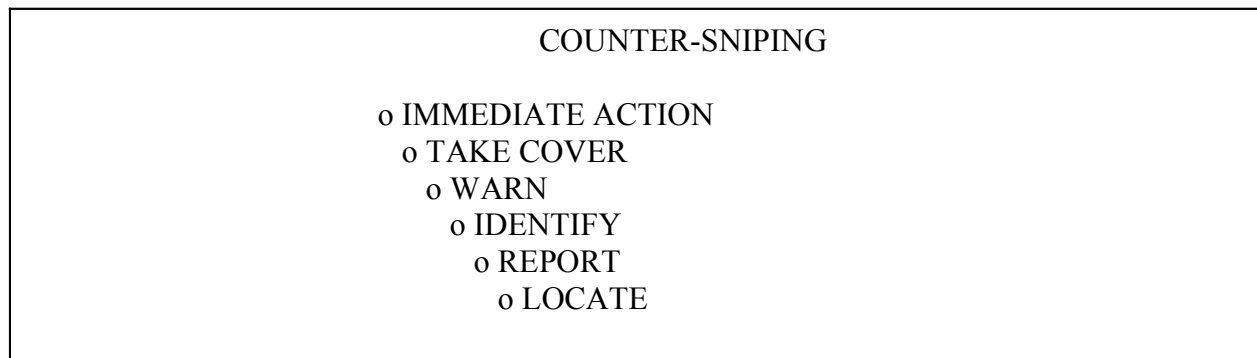

FIGURE 2-5. NEUTRALIZATION OF SNIPER FIRE.

3. Snipers.

a. Counter-sniping.

(1) Soldiers committed to civil disturbance control operations must be well-trained and rehearsed in the quick action that must be taken to stop sniper fire. Actual termination of the sniper should be accomplished by a special reaction team. The success of this team would depend upon the quantity and quality of prior planning and the proper preparation for handling such incidents. (See Figure 2-5)

(2) Immediate Action. The individual soldier or control force unit or team that encounters sniper fire should accomplish the following:

- (a) Take Cover. All exposed personnel should immediately seek cover whenever possible.
- (b) Warn. Notify all bystanders to clear the area or seek cover.
- (c) Identify. Ensure that sniper fire has, in fact, been encountered. Automobile backfires, firecrackers, light flashes, accidental weapon discharges, random firing by control forces, or distance sounds of firing may all be misidentified as sniper fire at your position.
- (d) Report. After verifying the sniper fire, inform the appropriate personnel of the situation so that help can be sent to the scene if required.
- (e) Locate. Try to fix the exact position of the suspected sniper or snipers. Inform the special reaction team leader of the sniper's location.
- (f) Do not, during any of the immediate action steps, return the fire unless a positively identified target is available and the requirements for the use of force can be met. If firing is necessary, it is accomplished by a selected marksman acting on orders from an officer or the senior person present..

The military leader must make every effort to prevent a disorganized mass return of fire that will likely endanger innocent persons. When crowd control formations are being used, the threat of sniper fire increases. Members of the control force should be aware, however, that persons in the crowd may try to disrupt the formation by the use of loud noises, such as fireworks or bursting paper bags. Members of the control force should be alert to such tactics to prevent disruptions during attempts to maintain order.

b. Securing the Area. After the individual soldier or control force unit or team has taken immediate action, steps should be under-taken to secure the area. In most situations, however, it will be necessary to commit reserves or other control force elements. Regardless of what forces are used, the senior member of the element responsible for securing the area should accomplish the following:

(1) Isolate. Notify all control force units not committed to the termination of the sniper to stay clear of the danger area. Establish roadblocks or checkpoints to keep unauthorized personnel out of the area to block the escape routes of the sniper. Isolation should take place far enough away from the danger area to prevent exposure to sniper fire.

(2) Evacuate.

(a) When meeting a sniper in a lightly populated area or building, make an announcement advising residents to clear the area or building using a specific exit. Those personnel exiting the building or area should be screened and identified since the sniper may well be one of them. Witnesses and those suspected of involvement with the sniper should be detained. Some residents may be unwilling, unable, or afraid to leave the area or building. A second announcement should also be made advising the remaining residents to seek cover, remain still, and stay away from exposed areas and windows.

(b) When meeting a sniper in a heavily populated area or building where evacuation is impractical, make an announcement to warn all residents to seek cover, remain still, and stay away from exposed areas and windows.

(c) Observe. Establish observation posts on rooftops and in windows or adjacent high buildings. Communications should be provided to the observers. A selected marksman, under appropriate orders, may also be used with the observation posts.

(d) Support. Be prepared to provide necessary support to the special reaction unit. Such support may include:

1. Establishment of a staging area for emergency and support equipment as well as for the team.

2. Establishment of a command and communications center for the coordinated control of the operations.

3. Control of crowds.

(3) Employment of the Special Reaction Team. The actual search for and apprehension of a sniper is a difficult and dangerous operation. It should be performed by a special reaction unit which has been trained and equipped for such operations. The procedures outlined in this paragraph are suitable for the team or for other control force elements assigned to terminate sniping when a team is unavailable.

(4) Establishment of a Command Post. The command element of the team should establish a central location for the coordination of all elements. Communications should be set up and maintained with the

force securing the area and with observation posts. In addition, continuous communications between the action and security elements must be maintained once they are deployed so that the progress of the search team can be monitored and so that the cover team does not mistake persons in the search team for the sniper.

(5) Deploy the Security Element. In order to observe sniper actions and all exits, the security element should be positioned outside the immediate area. In addition, the security element should establish a preferred route of entry into the area or building for use by the action element. The security element's selected marksman should be positioned at a location giving him the best possible observation and field of fire. If necessary, the selected marksman may fire at the sniper or snipers when they can be positively identified as snipers, when they are continuing fire, and when the requirements of the use of deadly force are met. This fire should be accomplished only by the selected marksman under the guidance and orders of the commander.

(6) Prepare the Action Element for Entry Into the Area or Building. Preparation should include:

- (a) A briefing on the area or building through the use of maps, drawings, and knowledgeable residents.
- (b) Equipment and communications checks.
- (c) The issuance of an operations order.

(7) Prepare and Issue Warnings and Instructions to the Sniper. The sniper should be given enough time to surrender.

(8) Attempt to Force the Sniper Into the Open. In open terrain or when meeting a sniper in a small unoccupied building, use crowd control agents in an attempt to force the sniper into the open where he can be taken into custody with less risk. Before using crowd control agents directly into the sniper's location, saturate the areas and rooms adjacent to the sniper. This will prevent him from using unaffected areas.

(9) If the sniper cannot be forced out, commit the action element to the area or building.

(a) When committing the action element to an open area, crowd control agents should be used to saturate the area prior to entry. The action element should enter the area on one side of the perimeter established by the cover element and then proceed through the area toward the other side of the perimeter.

(b) When committing the action element to a building, the following methods of entry can be used:

1. Entry at the top. Whenever possible, buildings are entered and searched from the top down. A sniper who is forced to the top may be cornered and fight desperately or escape over rooftops; one who is forced down to the ground level may try to withdraw from the building, leaving himself open to capture by the security element. Various means may be used to gain entry such as ladders, drainpipes, vines, toggle ropes, grappling hooks, roofs of adjoining buildings, or public utility vehicles designed for work on tall structures. Helicopters may also be used to deploy the action element on top of buildings.

2. Entry on middle floor. Sometimes it is impossible to enter a building at the top. In these instances, entry should be made at the highest possible point using the techniques described



above. The floor on which entry is made should be thoroughly searched and secured first. The action element then moves to the top floor and searches from the top down.

3. Entry at the bottom. When entry must be made at the ground level, armored personnel carriers should be used to gain entry and provide protection. Smoke may also be used to hide movement. When entering single-story buildings, it may be preferable to use crowd control agents to saturate the building before the action element enters.

(c) Search the Area or Building. A systematic search for the sniper must be conducted.

1. In an open area, the action element should maneuver and search under the protection of cover, firing only when necessary to protect life and property. Either the security element or the action element may use crowd control agents to aid the advance of the action element. Fire by selected marksmen may also be employed, if necessary. The "base of fire" technique (massed firepower) should NOT be used since it is destructive and creates hostility among innocent persons who suffer property damage or injury. The security element on the side of the perimeter where the action element entered the area should gradually close the perimeter as the action element moves forward. The security element on the opposite side should remain in position as the "noose" closes. The purpose of this action is to force the sniper to withdraw, leaving him open to capture by the security element. The techniques used for terminating a sniper in an open area will require close coordination and communication between all elements involved.

2. In an unoccupied building, when the sniper's location is not known, all rooms must be searched by at least two men. One man may throw a crowd control agent grenade, then enter quickly and place his back against the nearest wall. The second man follows and searches the room in detail. The action element leader should be kept informed of the progress made.

3. In an occupied building, when the sniper's location is unknown, all suspected rooms must be searched. The action element should try to have occupants submit voluntarily to the search of their rooms. At the same time, occupants should be questioned in an attempt to pinpoint the sniper's location. If occupants will not submit voluntarily and there is probable cause to believe that the sniper is located in the room a search should be conducted as described above.

4. In a building, occupied or not, where the sniper's location is known, the action element should proceed directly to the immediate area of the sniper's location. The rooms near the sniper's location should be checked first to ensure that the sniper has not moved. Once the rooms adjacent to the sniper have been cleared, crowd control agents should be introduced into the sniper's room by either the action element using bursting-type grenades or the security element using grenade launchers from the outside of the building. The door to the sniper's room should be opened or, if necessary, broken down. Before entering the room, allow time for the sniper to exit the room. If he does not do so, proceed with caution into the room.

5. Apprehend the Sniper. Whenever possible, the actual apprehension of the sniper is left to the civil police with help provided by military forces.

#### 4. Integrated Tasks.

a. General. There are many additional tasks which must be fulfilled along with the five additional operational tasks. Some are more important than others and the following inclusions by no means exhaust the list of these integrated tasks. The extent of their use will depend on the nature of control force involvement in the civil disorder.

b. Specific Tasks.

(1) Gather, Record, and Report Data. Each functional element of the control force, regardless of size, acts as a source for providing vital data upon which commanders at all levels can base their decisions. Additionally, the requirements imposed for after-action reports, investigations, and other administrative or judicial actions make it desirable that detailed unit journals or logs be kept by each separate operating element. Consideration should be given to naming a person in each squad or platoon to act as a recorder for the purpose of keeping an accurate journal of the unit's activity. Personnel named to act as recorders should be equipped with appropriate recording devices and a camera as a minimum.

(2) Apprehend Law Violators. The apprehension of the individual law breaker is a vital function during confrontation management operations because of the legal consideration involved; however, civil police should make the actual apprehension whenever possible. When military forces detain or take a civilian into temporary custody he will be turned over to civil police as soon as possible. The apprehending individual will be required to complete DA Form 2708, Receipt for Inmate or Detainee, at the collection point. This form, when properly completed, can provide civil authorities with all the basic data required in case of prosecution. It further provides for proper control of those persons detained.

(3) Maintain Communications. Effective communications between all control force elements, both within the military chain of command and with other law enforcement agencies, must be assured. Radio equipment may require extensive interchange between military, state, and municipal agencies to provide for cross-agency communications. Other planning considerations are the provision for alternate means, such as commercial radios, pay telephones, and visual signals.

(4) Maintain Mobile Reserves. The control force commander and subordinate commanders must have the ability to respond to unexpected requirements and to influence adverse situations. To this end, mobile reserve forces should be set up and kept in readiness. Mobile reserves should be located at secure locations close to the disturbed area to permit employment within minutes. The reserve force must be reconstituted quickly upon commitment.

(5) Inform the Public. To deter the spread of rumors and false data, the control forces must ensure the public is informed of the true nature and purpose of the measures being imposed upon them. This is particularly important where dissident elements are known to be presenting false or distorted data. Procedures must be set up to give news media access to the disturbed area and to the facts, if they are denied this opportunity; their news coverage will likely be based on speculative or false data. Additionally, rumor control centers operated by the control force may be required to deter the spread of word-of-mouth rumors.

c. Firefighting Task Operations.

(1) General. In many civil disturbances, the existence of destructive violence, particularly demonstrated by the setting of fires, requires that detailed consideration be given to the immediate and effective response designed to limit the effect of such destruction.

(2) Firefighting Task Forces. A primary factor in such a response will be the firefighting task force, which should be composed of a number of pieces of equipment and the required operational and security people. The concept is to provide a mobile force capable of moving rapidly, having enough equipment to quickly put out or contain large fires and then move on. In order for a task force to be efficient, the following considerations should be made:

(a) A specific area of operation should be named.

(b) Several task forces should be created.

d. Security of Firefighting Task Forces. The primary mission of the firefighting task force is containing fires and due to that total commitment, the task force must depend on other agencies for its security. Firefighting personnel and equipment are extremely open to harassment and attacks by crowds or individuals. This mission of security will normally be assigned to military units which have been committed. When creating such a security force, two important areas must be addressed:

(1) Size. The size of the force will depend upon several factors such as:

(a) Size of the firefighting task force.

(b) Level and amount of hostility found in the area of operation.

(c) Available personnel and equipment that can be allocated to the mission.

(2) Techniques. Methods of providing security will incorporate a number of concepts.

(a) Mobility is a must and the best means to ensure this is to provide the security force with sufficiently equipped vehicles and communication equipment. Vehicles should have flashing, emergency lights to enable them to move safely or provide appropriate escort vehicles. Security personnel should never ride or position themselves on fire fighting equipment. The humanitarian (non-threatening) image must be maintained in the public.

(b) The following considerations should be observed at the fire scene:

1. The military unit leader should contact the senior fireman present and provide aid.

2. A protective cordon should be established around the fire service while it is operative. The cordon should face outward and personnel should be assigned areas of responsibility.

3. All vehicle and pedestrian traffic entering the area should be blocked.

4. Observation posts should be positioned in any tall building to prevent sniper attacks.

5. Any hostile crowd activity should be controlled using appropriate crowd control techniques. If necessary, reinforcement should be promptly requested.

6. Process detained personnel.

(e) Anti-looting measures.

General.

(1) Looting may start at any time or place as an isolated incident and quickly spread throughout the affected area. From previous civil disorder, looting of businesses has emerged as a problem calling for quick prevention action. Looting may take place at random throughout the time that an area is in turmoil.

- (2) From a previous discussion we know that looters are from all walks of life; young, old, male, and female. Again, emphasis is placed on the use of force which should be no more than necessary.
- (3) Lessons learned from various disorders have shown that looters will normally start with liquor stores, arms and ammunition stores, and drug stores. However, looters will also take such things as food, furniture, watches, rings, clothes, candy, television sets, major appliances, etc., whether they need them or not. Department stores may be looted and then burned in order to destroy records of money owed by the looters.
- (4) Control of looting. The amount of force needed and the techniques used to control looting will vary considerably within the area of operation. As a general rule, looting should be stopped as quickly as possible to prevent it spreading to those who would not normally loot except when caught up in the actions of others. The following control measures will help in this objective:
- (a) Isolation and control of the affected area by use of barricades and road blocks to prevent looters from increasing in numbers.
  - (b) Establishment of saturation patrolling and stationary guard posts within the affected area to prevent looting.
  - (c) Quick arrest and removal of violators.
  - (d) The techniques applied and the amount of force used will depend on the situation and the instructions issued to the commander. As a general rule, looters should not be fired upon merely to prevent their escape.
  - (e) Looting can be expected to increase during hours of darkness. Therefore, favorite looting targets should be patrolled often and special night lighting should be used when and wherever possible to discourage open acts of looting. In addition, peak periods of looting activity should be carefully charted and increased efforts used during these times.

## **SUMMARY**

During the course of this lesson you have learned how to use crowd control, counter sniper, building search techniques and supervise immediate action to be taken upon a notification of an explosive device as well as actions to be taken in the event you come in contact with an explosive device. Additionally, we have learned that confrontation management operations require control forces which can effectively confront a variety of crowds and mobs and maintain order once it has been established.

## **Lesson 2 Test**

The following questions are multiple choice and true/false. You are to select the one that is correct. Show your choice by CIRCLING the letter beside the correct choice directly on the page. This is a self-graded lesson exercise. Do not look up the correct answer from the lesson solution sheet until you have finished. To do so will endanger your ability to learn this material. Also, your final examination score will tend to be lower than if you had followed this recommendation.

1. There are several options for crowd control, for large nonviolent demonstrations, where decisive action is not possible, the best option would be

- A. Disperse.
  - B. Contain.
  - C. Monitor.
  - D. Block.
2. Which of the following is not used in the task of area control?
- A. Fixed guard posts.
  - B. Motor patrols.
  - C. Curfew.
  - D. Air patrol.
3. When encountering an explosive device, which of the following actions should be taken?
- A. Notify all personnel to clear the area.
  - B. Visually examine device to relay such information to EOD en route.
  - C. Place sandbags around the device.
  - D. Try to disarm device.
4. When conducting a bomb search, search teams should consist of
- A. Only the control force.
  - B. Control force and select building occupants.
  - C. Control force and civil unit.
  - D. Only the civil police unit.
5. Deadly force may be used in the prevention of arson act.
- A. True.
  - B. False.
6. What are the two types of searches that can be conducted of a building during a bomb threat?
- A. Bomb Technician Search and EOD Search.
  - B. Specific area Search and General Area Search.
  - C. Supervisor Search and Search Team Search.
  - D. Firefighter Search and EOD Search.
1. When military forces detain or take a civilian into temporary custody he will be turned over to civil police. The apprehending individual will be required to complete:
- A. DA Form 3975 Military Police Report.
  - B. DA Form 4137 Evidence/Property Custody Document.
  - C. DA Form 2823 Sworn Statement.
  - D. DA Form 2708, Receipt for Inmate or Detainee,
1. When committing the action element to a building, what is the preferred method of entering the building?
- A. Enter through a window.
  - B. Enter from the highest entry point.
  - C. Enter form the lowest entry point.
  - D. Enter from the middle floor of the building.
1. When encountering a sniper that is firing from inside of a building, the control force should:
- A. Create a team and assault the building.
  - B. Notify the special reaction team and let them handle the situation.

- C. Notify the closes air base for support.
- D. None of the above.

10. During a riot, firefighting personnel and equipment are extremely open to harassment and attacks by crowds or individuals.

- A. True
- B. False

## LESSON 2

### PRACTICE EXERCISE

#### ANSWER KEY AND FEEDBACK

Item	Correct Answer and Feedback
1.	C. Monitor. While monitoring... (page 2-4)
2.	A. Fixed guard posts. The techniques... (page 2-11)
3.	A. Notify all personnel to clear the area. Warn. (page 2-13)
4.	B. Control force and selective building occupants. Selected occupants... (page 2-15)
5.	A. True. The use of deadly force may be required to prevent acts of... (page 2-18)
6.	C. There are two types of searches that can be conducted, a supervisor search or a search team search. (Page 2-15)
7.	D. All of the above. Once a disorder... (page 2-14, para 2f(1))
8.	B. Entry at the highest entry point. Whenever possible, buildings are entered and searched from the top down. (page 2-21)
9.	B. Actual termination of the sniper should be accomplished by a special reaction team. (page 2-18)
10.	A. Firefighting personnel and equipment are extremely open to harassment and attacks by crowds or individuals. (page 2-23)

## LESSON 3

### CROWD CONTROL FORMATIONS

## OVERVIEW

### LESSON DESCRIPTION:

In this lesson you will learn the various crowd control formations and how to form up Soldiers into those formations.

### TERMINAL LEARNING OBJECTIVE:

**ACTION:** Describe crowd control formations and how they are formed.

**CONDITION:** You will have this subcourse.

**STANDARD:** To demonstrate competency of this task you must achieve a score of 70 percent on the subcourse examination.

**REFERENCES:** The material contained in this lesson was derived from the following publication: FM 3-19.15.

## INTRODUCTION

We know from our studies of the histories of war that success in battle is not always determined by the number of Soldiers or firepower. Success is more often determined by the discipline and training of the Soldiers involved. This situation often applies to civil disturbance control operations because our Soldiers can be expected to be greatly outnumbered. A system of crowd control formations has been devised to offset this shortage of numbers. It is vital that you have a thorough knowledge of this system of formations to help you to effectively employ your unit in a civil disturbance operation.

### PART A - TYPES OF FORMATIONS AND WEAPONS

#### 1. General.

- a. Crowd control formations, when properly used and effectively carried out; represent one of the most practical methods of controlling crowds. These formations are especially effective against a large crowd because they enable the control forces to split the crowd into small groups. However, commanders must realize their limitations; formations are not the answer to all disturbance situations. Soldiers should not be subjected to unnecessary sniper fire and violent acts of troublemakers simply to impress the mob with a show of force. When small dispersed groups are running wild in an area of operations, crowd control formations will be of little value in stopping the disturbance.
- b. With the development of non lethal weapons (NLW), the commander now has more options at his disposal. Before NLW, the only other choices were chemical irritants, military working dogs (MWDs), and lethal force. With the advances in NLW's, it is now possible to create an effective standoff distance of 15 to 100 meters between the crowd and the control force. Now commanders can create a standoff distance with NLW that reduces the risk of close fighting with the mob.
- c. Further, when a large mob has been broken up, the problem is not necessarily solved. It should not be assumed that rioters have returned to peaceful activities. It may well be that the small groups breaking away from the large group will engage in small mob tactics such as sniping, looting, and burning. If such a situation develops, commanders should apply the tactics discussed in the preceding lessons and continue active control measures until they are sure that law and order have been restored.

d. During CONUS operations, there are usually no enemy forces. However, the commander must still assess and secure the areas of operations (AOs). This can be done by the use of helicopters conducting over-flights observations or by visually securing rooftops, high elevations, and advantage points. When utilizing crowd control formations, they can not only be utilized to break up crowds but also have the capability to make apprehensions and detain certain personnel that the commander may feel will instigate the crowd to further violence.

e. The manner of using formations and NLWs, the application of a certain formation to a particular situation, and the stage of operations at which certain types of actions will be suitable, are matters which must be decided by commanders.

## 2. Actions Before Movement

a. Control force formations, when properly employed and executed against a crowd, are some of the most practical methods of crowd control. The riot baton has been the weapon of choice for the control force.. During any crowd control operation, the commander must protect the control force with lethal overwatch. This overwatch may be in the form of marksmen and observer teams (sniper with observer) and a response force with lethal capabilities.

b. Before moving the control force to the civil disturbance area and into a potentially hostile urban environment, the commander and his staff must review the preincident plans and expand them (as needed) based on current information. . During the planning phase, the information provided by the IPB will aid the staff in selecting various routes and rally points. The selection of ingress and egress routes must include a variety of ways in and out of the area. Direct and indirect routes and those with cover and concealment are necessary. The rally point must be cleared and secured by an advanced party capable of controlling the area.

c. Additionally, civil disturbance training must be part of the annual unit training plan. If a Soldier is deployed to an area where civil disturbances are a recurring event, sustainment training must occur more frequently. Before moving the control force to the rally point, an intense rehearsal must be conducted by the leadership and the control force. A top-down review of the rules of engagement (ROE/rules for the use of force (RUF) must be accomplished. The ROE/RUF must be part of the unit training plan and each Soldier must be trained to standard. The use of NLW (type specific) must be granted to the on-site commander from the approval authority.

3. Control Force Formations. Dismounted crowd control formations constitute a means of blocking the advance of a mob. The various crowd control formations are tools to be employed as required. Normally, the line can be employed against any size crowd, and the echelon and wedge against a small group on a narrow front or in confined areas. When Soldiers penetrate a crowd to capture one of its members, they may use a modified formation, such as a circular or a diamond formation, with at least two unarmed soldiers inside the formation; when the formation reaches the person to be seized, a gap is opened and the unarmed soldiers pull the person inside. These soldiers should be equipped with handcuffs and/or restraining straps for use in securing the person; however, the diamond and circular formations are open to being surrounded by the crowd.

## 4. Vehicle and Formations.

a. Vehicles can be employed with Soldiers in a control force formation. Although vehicles may add strength to the formation certain precautions should be taken to protect the Soldiers riding inside the vehicle such as covering the windshield with sturdy, close mesh fencing and standard safety glass. By placing a wooden or metal frame with strung barbed wire can also act as a barrier. Additionally, have the control force walk close to the side of the vehicle will prevent the crowd from attacking the sides and back of the vehicles. Vehicles may be used to obtain shock action; as a base to release crowd control agents; or to enter



a crowd to arrest selected instigators.

b. Up-armored HMMWVs, ASVs. or armored vehicles may be employed with the control force when determined by the mission, enemy, terrain, troops, time available and civilian considerations (METT-TC). These up armored or armored vehicle can have a great psychological effect on the crowd as well as protect members of the control force. The commander when utilizing these vehicles must keep in mind to maintain visual and control of the vehicle formation. The commander can place himself the rear of the vehicle formations and utilized vehicle radio communications to talk to the other vehicles. Additionally, he may have to convert to utilizing hand signals if for some reason radio communications are not working. Either way, the utilization of vehicle in a riot or demonstration must be practiced to be effective.

## 5. Type of Crowd Control Formations and Their Uses.

a. Control force formations when utilized properly can be an effective tool in crowd control. Experience has shown that the most effective control force formation is the line and wedge. The two less used formations are the diamond and circle. Descriptions of all the formations are as follows:

(1) Line formation: The line is the basic formation and it is used more often because of its offensive and defensive applications. As an offensive formation, the line is used to push or drive crowds straight back, across an open area, or up a city street. As a defensive formation, the line is used to hold the crowd or to deny access to areas.

(2) Echelon formation: The echelon is an offensive formation used to turn or divert groups in open or built-up areas and to move crowds away from buildings, fences, and walls.

(3) Wedge formation. The wedge is an offensive formation that is used to penetrate and split crowds into smaller groups.

(4) Diamond formation: The diamond, when used as an offensive formation, is used to enter a crowd and is the formation of choice for extraction teams. As a defensive formation, the diamond is used when all-around security is required in open areas. The decision to use this formation is based on the conformation of the crowd.

(5) Circular formation: The circular formation is used for the same purpose as the diamond formation. The decision to use this formation is based on the conformation of the crowd.

## b. Elements of a Control Force Formation

(1) Base element: The base element is made up of two ranks. The first rank is shield holders, while the second rank contains the NLW. This is the front line of the formation.

(2) Support element: The support element forms up in a column formation behind the base element and has a variety of uses. It may be used to replace base element members as needed, provide lateral or direct support, or perform extraction team operations. The support element helps the base element by performing the following three essential tasks:

(a) General support: The general-support element is formed from an uncommitted squad in the platoon (generally the 2d squad). When a company is tasked as the control force element, one of the platoons becomes the general-support element. The element is in a column formation centered on and behind the main formation. From this formation, the general-support element can move to lateral or direct support, as needed.

(b) Lateral support: The lateral –support element is used to protect the flanks of the formation. This is done by moving a set number of teams forward from the general-support element or by using the end teams in the formation; however, this will make the formation smaller. Once in position, three teams become part of the formation, with their riot shields facing the flanks of the formation.

(c) Direct support: When direct-support is ordered, the general-support element moves forward as they form their own formation. While moving forward, the squad and team leaders form the control force formation step back and allow the riot shield holders from the support element to step behind riot shield holders of the original formation. This allows the support riot shield holders to form up between and behind the riot shield holders between the crowd and NLW fires. This formation is the strongest of the formations and requires more planning and practice to master.

(d) Command element: The command element contains several different members. A general configuration for the command element is the platoon leader, the platoon sergeant, a radio operator, a video recorder operator (is required), and an interpreter (if required). This element does not have a fixed location within the formation and moves about as needed.

(e) Lethal over watch elements: The lethal over watch element is a team formed from reserve security forces.

6. Normal Preliminary Procedure. A show of force is often a useful tool for dispersing crowds. When the soldiers arrive at the scene, the psychological effects of their arrival can be utilized. Soldiers should make a strong surprise appearance using the following procedures:

a. Soldiers should dismount from helicopters, busses, trucks in plain sight of the crowd. Caution must be taken that the rally point is close enough to the crowd to present a strong psychological presents but far enough away from the demonstrators to prevent or provoke attacks of thrown objects.

b. The commander should place his lethal over watch (designated marksmen {DM} teams) in areas that have a good field of vision over the crowd and control force. The DM teams can be sent to the flanks and slightly to the front of the formation. It is their responsibility for protect the control force from any lethal actions on the part of the crowd by continually scanning the crowd.

c. When the commander receives word that the DM teams are in place, he will form the control force into a crowd control formation and move them from the rally point to where the demonstrator are located. Depending on the situation, the commanders should move the control force in a column formation or one of the three basic control force formations.

d. Reserve forces need to stay at the rally point until it is deemed necessary that they are needed to reinforce the formation or provide additional lethal over watch for the control force formation.

e. The unit halts and remains in formation. The Soldiers hold their riot shields at the ready position while the commander delivers the proclamation. Following the proclamation, the commander informs the participants that they have a specific time in which to comply with the order to leave.

f. If the participants fail to leave within the given time, the commander uses measures necessary to break up the crowd.

7. Special Preliminary Procedure. If rioters are known to be well-armed, and intelligence reports show that they intend to open fire as soon as Soldiers appear, the commander may not make a show of force, but may

launch a crowd control agent attack from covered or hidden positions.

## 8. Lethal and Non Lethal Weapons Used in Formations.

a. Riot Shield: The riot shield has been proven over time to be the first line of defense for a formation. The riot control shield may also be used as an offensive weapon when in contact with an aggressive crowd. The riot shield is designed to withstand strikes from thrown objects. In addition to protecting the riot shield bearer, it also protects other members of the formation from thrown objects.

b. Baton: The baton is considered the primary weapon for crowd control operations. It is an offensive weapon and unlike the rifle, the loss of baton to the crowd does not create a serious threat. Soldiers must be trained with the riot baton to the point that its various techniques are automatic. This training must also include learning the vulnerable points of the human body so they can avoid areas that may cause permanent injury or death when struck, (See FM 3-19.15 for targets areas of the human body).

c. Rifle. The rifle is the most practical weapon for general use by Soldiers in crowd control formations if batons are not available. If the control force must carry their assigned rifle it should be carried across the back with the barrel pointed toward the ground and the butt of the weapon pointed toward the sky.

d. Shotgun. The 12-gauge shotgun is a pump action shotgun currently in non lethal capabilities set (NLCS) inventory. The pump action shotgun is chambered to take up to 3-inch shell. The 3-inch chamber allows for the use of M1012 and M1013 non lethal munitions. This shotgun also provides a visually distinct alternative to standard military weapons that may be desired based on mission considerations (force signature and acceptability). A list of nonlethal munitions that can be utilized with the 12-gauge shotgun are listed below:

(1) 12-Gauge, Fin-Stabilized Point, Nonlethal Cartridge (M1012): The M1012 is a single projectile round made of hard rubber that is shaped like a bomblet and designed to be fired at a single target. With a muzzle velocity of 500 feet per second, the M1012 has the effective range of no closer than 5 meters and no further than 30 meters. Engagement inside 5 meters could cause serious injury or death. Beyond 30 meters the kinetic energy dissipates to the point where the round becomes ineffective.

(2) 12-Gauge, Crowd Dispersal, Nonlethal Cartridge (M1013): The M1013 is a multiple projectile round with .23 caliber hard rubber pellets that is designed to be fired at and employed with the purpose of affecting multiple targets. With a muzzle velocity of 900 feet per second, the M1013 has an effective range of no closer than 5 meters and no further than 30 meters. Engagement inside 5 meters may cause serious injury or death. Beyond 30 meters, the kinetic energy dissipates to the point where the rubber pellets become ineffective.

(3) Rubber Ball Grenade (GG04): The GG04 is a multiple projectile, flash-bang grenade with 100 .25-caliber hard rubber pellets. Each grenade has a fuse delay of 2.8 to 3 seconds with a flash measuring approximately 1 million CP and 180 decibels at 3.5 feet. At detonation, rubber pellets are dispatched at 360° with an effective range of 2 to 3 meters and a maximum engagement range of 15 to 20 meters. The rubber ball grenade is designed to be hand-thrown or muzzle-launched from a 12-gauge shotgun.

(4) Rubber Ball Grenade Launching Cup and AA30 12-Gauge Launch Round: The launch cup firmly attaches to the 12-gauge shotgun without any additional tools. It works in concert with the AA30 12-gauge launch round to propel the rubber ball grenade approximately 100 meters. The shooter simply inserts the full body and the safety lever of the grenade into the launching cup, pulls the pin, loads a 12-gauge round, and fires (approximately) at a 30° angle. The desired effect is to have the grenade explode approximately 7 to 10 feet above the target.

e. Sniper rifle. When available, each platoon should have one sniper rifle which is carried by a selected marksman to fire at specific targets as directed by the platoon leader or company commander.

f. Hand weapons. Hand weapons may be carried by the commander, drivers, grenadiers, extraction teams, apprehension teams, and other personnel when it is impractical to carry rifles. They are used primarily as defensive weapons.

g. Portable dispersers. Currently in the NLCS numerous chemical dispersers are available for use during a demonstration. Some of these portable chemical dispersers are mentioned below:

(1) Individual riot Control Agent Disperser (M36): The M36 contains a Dibenz solution. It can deliver 25 one-second bursts out to 12 feet. Individual disposable Riot control Agent( RCA) disperser are intended primarily for self-defense or to keep rioter out of arm's reach of soldiers conducting crowd control formations or Soldiers engaged in missions where a noncombatant exist.

(2) Midsize Riot Control Agent Disperser (M37): The M37 is the size of a standard fire extinguisher that uses compressed air to force the RCA out to a range of 30 feet. It has the capacity to employ 18 burst for 3 seconds per charge. It is excellent for providing a wide coverage of RCA onto hostile crowd while maintaining excellent standoff capabilities.

(3) Squad Riot Control Dispenser (M33A1): The M33A1 is designed to provide crowd control and protection at the squad level. It is capable of projecting a ballistic stream of RCAs beyond 25 feet in up to 25 half-second bursts. It consists of a frame and harness assembly, compressed-gas cylinder (agent container assembly), air pressure assembly, gun and hose, assembly, mutijet spray unit, and check valve assembly. The M33A1 can be refilled and is rechargeable.

h. M234 Riot Control Launcher: This projectile fired from the M234 launcher has sufficient momentum to cause pain and discomfort in order to deter individual violent rioters with minimum possibility of producing injury. For more determined or fanatical rioters, the system can also use a round that will disperse a tearing (CS) agent while it hits the person. The M234 maximum range for a point target is 40 meters and area target is 60 meters. Only an M16A1 with closed end flash suppressor can be used for the M234. The M234 is scheduled to be modified at depot level for the M16A2.

i. M203 grenade launcher. The M203 grenade launcher firing the CS cartridge is used to engage selected point or small area targets at a range of 200-400 meters. Additionally, other the following nonlethal munitions may be used with the M203:

(1) 40-Millimeter Sponge Grenade (M1006): The M1006 is a single projectile round made of pliable foam rubber with a hard plastic back. The M1006 is designed to be aimed and fired at a single target. With a muzzle velocity of 265 feet per second, the M1006 has an effective range of no closer than 10 meters and no further than 50 meters. Engagements inside 10 meters could cause serious injury or death. Beyond 50 meters, the kinetic energy dissipates to the point where the round becomes ineffective.

(2) 40-Millimeter Crowd Dispersal Cartridge: The crowd dispersal cartridge (CDC) is a multiple projectile round with .48 caliber hard rubber balls that is designed to be fired and employed with the purpose of affecting multiple targets. With a muzzle velocity of 450 feet per second, the CDC has an effective range of no closer than 10 meters and no further than 30 meters. Engagement inside 10 meters could cause serious injury or death and beyond 30 meters the kinetic energy dissipates until the rubber balls become ineffective.

j. M7 66-Millimeter Launcher with M315 Installation Kit: The M7 is a 66-millimeter vehicle-mounted, NL, grenade-launching device that is mounted on a HMMWV. It is an indirect fire support system that can deliver the M98 distraction grenade that creates a flash-bang effect, L96A1 antiriot grenade, or M99 blunt trauma grenade that creates a sting-ball effect. The M315 installation kit is used to install an M7 discharger on the turret ring of appropriate HMMWV variants. An adjustable bracket allows the launch angle to be depressed for engaging targets at ranges of 50, 75, and 100 meters. The system enforces standoff distances and deters potential threats.

9. Position for Carrying Weapons. At the discretion of the unit commander, the Soldiers may carry their weapons in any of the positions prescribed by FM 3-21.5. The descriptions and illustrations given below pertain to the 12-gauge pump shotgun. The following positions are used as indicated:

a. Safe-port arms.

(1) Command. PORT ARMS (two count movement).

(2) Position (see Figure 3-1).

(a) On the command of execution ARMS, grasp the shotgun barrel with the right hand and raise the shotgun diagonally across the body, keeping the elbow down (without strain).

(b) The left hand will grasp the hand guard at the base of the stock.

(c) On count two, regrasp the shotgun at the small of the butt stock with the right hand. Hold the shotgun diagonally across the body, about 4-inches from the waist.

(d) Upper left arm is parallel to the ground, and forearm is as perpendicular to the ground as body conformation permits.

(e) Elbows are held as close to the body as body conformation permits.

(f) Heel of the rifle butt is held slightly to the right of the waist belt buckle.

(g) Weapon is held just diagonally enough across the body to permit the person to look straight to the front over the right side of the stock.

(3) Use.

(a) The safe-port position is extremely useful in making a show of force before rioters. The above mentioned carrying position is the primary method of carrying weapons in the control force formation. It allows the Soldier to control both ends of the weapon while moving in and out of the formation and advancing the crowd.



FIGURE 3-1.SAFE-PORT ARMS

(b) Soldiers move into and gather from all crowd control formations with weapons in the safe-port position. The command safe-port arms is given while the Soldiers are in column prior to execution of any crowd control formation. Soldiers will automatically assume the port position before reassembly from a crowd control formation.

(c) Commanders should use the safe-port position to impress rioters. However, Soldiers should not be required to maintain the position for extended periods of time as it is very tiring.

b. High-port arms.

(1) Command. High-port arms (two count).

(2) Position (see Figure 3-2).



FIGURE 3-2. HIGH-PORT ARMS

(a) Right hand grasps the weapon on small portion of the stock; the under and inner part of the forearm against the top of the stock; the shotgun is held across the body.

(b) Left hand grasps the hand guard at the most comfort-able point forward of the balance point; left arm is slightly bent.

(c) Both the right and left arms are raised to lift the shotgun approximately 6 to 8 inches higher than the safe-pot position.

(d) When at the halt, the feet are comfortably apart, toes pointed at rioter; knees slightly bent; body leaning slightly forward; and the hip level.

(4) Use.

(a) The high-port position is a position of complete readiness. It is used whenever Soldiers are in contact with a crowd that is showing resistance or is not withdrawing. .

(b) Commanders should rest Soldiers at every opportunity by using less tiring positions. The "high-port arms" position is too tiring to maintain for long periods of time.

#### PART B - Unit Organization for Crowd Control Formations

**NOTE: The formations covered in this lesson (12-man squad, 4-squad platoon, 3-squad platoon, 3-platoon company with 4-squad platoons) are for illustration only, and are not intended to require unit reorganization.**

1. Commands.

a. Oral commands.

(1) Commands are given to the control force formation orally or with hand signals. Oral commands for the on-guard position are given in one count. All other commands are given I tow count, a preparatory command and a command of execution. If the commanders' oral commands cannot be heard by the control force he may have to utilize hand signals.

(2) If vehicles are in the formation, radio's become an alternate method for relaying commands. The commander may utilize both oral and hand signals to improve his communications with the control force.

b. Hand signals. When necessary, hand signals should be used by commanders in conjunction with oral commands. Hand signals for crowd control formations may be given as follows:

(1) Line. Raise both arms to the side until horizontal, arms and hands extended, palms down. (See Figure 3-3.)

(2) Echelon right (left): Extend one arm 45-degrees above and the other 45-degrees below the horizontal, palm to the front. The upper arm shows the direction of echelon when the commander faces the formation. (See Figures 3-4 )

(3) Wedge: Extend both arms downward and to the sides of an angle approximately 45-degrees below the horizontal, palms to the front. (See Figure 3-5.)

(4) Diamond: Extend both arms above the head, elbows bent slightly and fingertips touching. (See Figure 3-6.)

(5) Circle: Give the diamond signal, then give a circular motion with the right hand. (See Figure 3-7)

NOTE: Hand signals indicated by the silhouettes are as if facing the formation.



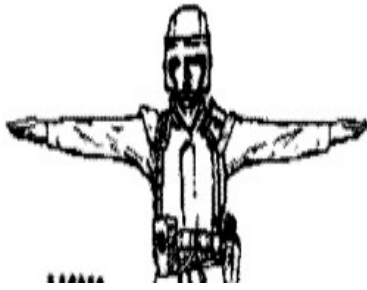

FIGURE 3-3. LINE.



FIGURE 3-4. ECHELON RIGHT or LEFT.



FIGURE 3-5. WEDGE.



FIGURE 3-6. DIAMOND.



FIGURE 3-7. CIRCLE.

## 2. Cadence.

- a. The normal cadence for movement into and assembly from all crowd control formations is double time (180 steps per minute).

- b. The normal cadence for movement of Soldiers while in any crowd control formation is quick time (120 steps per minute). While in the on-guard position, the cadence is approximately 60 steps per minute. For psychological effect, an on-guard step may be executed by accentuating each step on the left foot with a resounding stamp.
- c. Cadence may be increased or decreased at the discretion of the unit commander to meet varying situations.
- d. A unit may be ordered into or assembled from crowd control formations from the halt or while marching. As each man reaches his proper position, he automatically faces in the direction of the unit's intended advance and comes to a halt. He remains at the halt in the safe-port position and awaits further orders.

3. Position of Commander and Leaders.

- a. When in column, the commander at each echelon normally assumes his position at the head of the column.
- b. When in crowd control formation, squad leaders and their teams, platoon leaders and teams, and company commanders take positions in the rear of the assault elements of their respective units where they can best direct and control their units. In the illustrations of crowd control formations, the platoon and squad leaders are not shown uniformly in order to illustrate the flexibility of their positions behind the formations. The symbols listed below are a key to identify Soldiers within crowd control formations (see Figure 3-8).
- c. When in column, messengers (radio operators), selected marksmen, dispersers, and other members of platoon headquarters normally take positions at the rear of the column.
- d. When a unit is in a crowd control formation, headquarters personnel, at the discretion of the unit commander, are positioned near the commander. If the situation prevents this, they may be positioned behind the assault element.

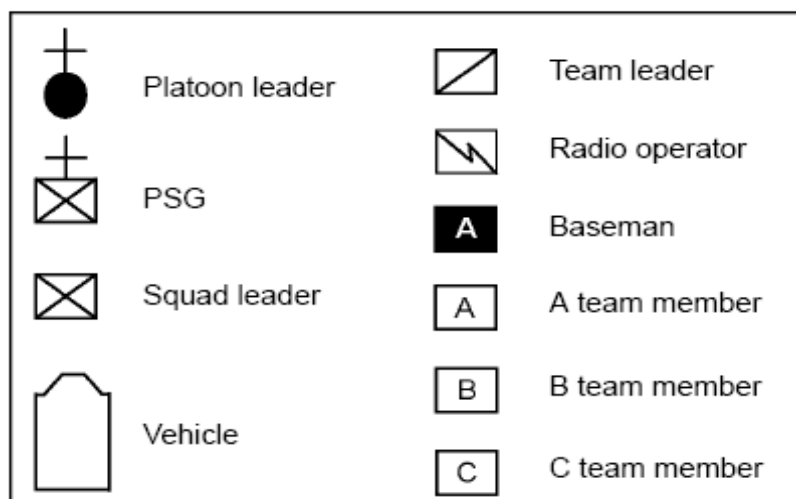

FIGURE 3-8. Key To Symbols Used to Identify soldiers within A Crowd Formation.

4. Interval and Distance.

a. Interval is the lateral space between elements. Distance is the space between elements in a column. The usual interval and distance between soldiers in control force formations is 30 inches. The interval and distance can be adjusted based on METT-TC. If the crowd has to be physically pushed back, a close interval is preferred. This allows the riot shields to be overlapped, creating a stronger wall. During peaceful demonstrations, the interval could increase to double arm width, allowing the formation to cover more area and still control the crowd. The interval and distance could change several times during the course of operations before the crowd is dispersed.

b. In any echelon formation with normal interval and distance, the angle made by the formation and the route of advance will be approximately 45 degrees. The angle formed by the two wings of any wedge formation will be approximately 90 degrees when normal interval and distance are used.

5. Masking Procedures. When it is necessary to use crowd control munitions to break up an unruly mob, or when intelligence indicators point to mob use of chemicals, protective masks will have to be worn. A key consideration in this regard is not to break formations while Soldiers are masking. Consistent with the security of the Soldier, any of the following methods may be used.

a. Every other man drops back one or two paces, dons his mask, then resumes his place in the formation. The other half of the formation then performs the same act.

b. Remaining in formation, Soldiers in every other squad put on their masks. Then remaining Soldiers don their masks.

c. If there is sufficient space between Soldiers and a crowd, all men may don their masks at the same time.

d. Reserve units put on masks and replace units in the line. This act is repeated until all Soldiers are masked and a new reserve is constituted.

e. When chemicals have been used by rioters, or early use of crowd control agents is anticipated by the commander, Soldiers may be ordered to mask prior to commitment.

## PART C - Squad Formations

1. General. When executing squad crowd control formations from the column, the squad leader takes one or more steps to the right and faces his squad. As he gives his preparatory command, he points to the location at which he desires the formation to be formed. If he does not point, the squad forms on the position of the number 2 man (base man) of the squad.

2. Squad Line.

a. Command. "Squad Line Formation, Move."

b. Execution. On the command of execution, the A team leader leads the baseman to the place indicated by the squad leader. The squad members align themselves in sequence with the baseman at normal intervals. Based on the situation, the squad leader may designate a specific interval. He does this when he gives the preparatory command. If no interval is specified, the squad automatically forms using the normal interval. (See Figure 3-9).

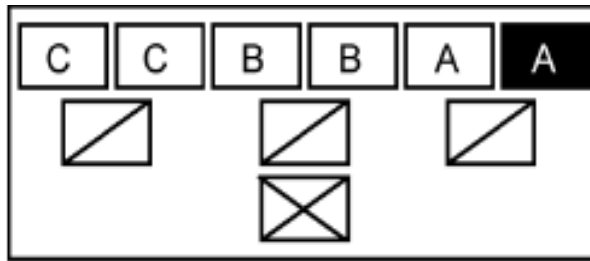

FIGURE 3-9. Squad Line

### 3. Squad Echelon Right or Left.

Command. "Squad Echelon Right (or Left), Move." On the command of execution, the A team leader places the baseman at the location indicated by the squad leader. The squad members align themselves in sequence with the baseman, one pace to the side and one pace to the rear. (See Figure 3-10).

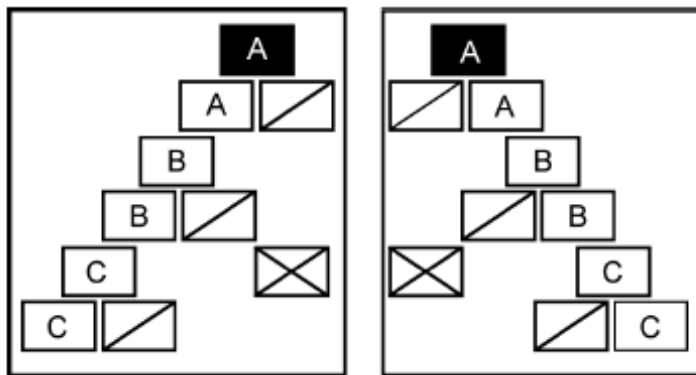

Figure 3-10. Squad Echelons Right Left and Right.

### 4. Squad Wedge.

a. Command. "Squad Wedge, Move."

b. Execution. At the command of execution, the base man advances to the position named by the squad leader. Even-numbered men align themselves in sequence on the base man, one pace to the right and one pace to the rear of each preceding man. Odd-numbered men align themselves in sequence on the baseman; one pace to the left and one pace to the rear of each preceding man (see Figure 3-11).

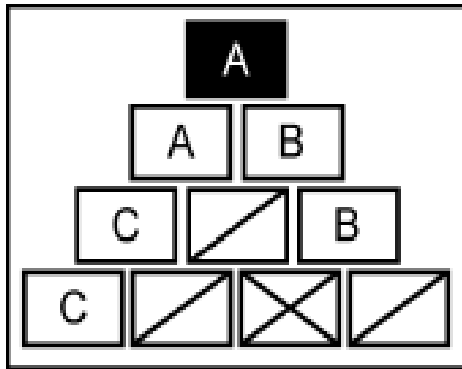

FIGURE 3-11. Squad Wedge.

5. Diamond and Circle Formations.

- a. The diamond and circle formations are used during extraction team operations. They are small formations used to penetrate the crowd or cover small areas. The decision on which formation to use is based on METT-TC and the ability of the squad to perform.
- b. Commands for forming a squad in a diamond or circle formation is “Squad Diamond (or Circle), Move.” On the command of execution, the A team leader moves the baseman to the place indicated by the squad leader. The A-team lines up to the left of the baseman, covering the 8 to 12 o’clock positions. B-team members align themselves to the right of the baseman, covering the 12 to 4 o’clock positions. C team members align themselves covering the 4 to 8 o’clock positions (see Figure 3-12).

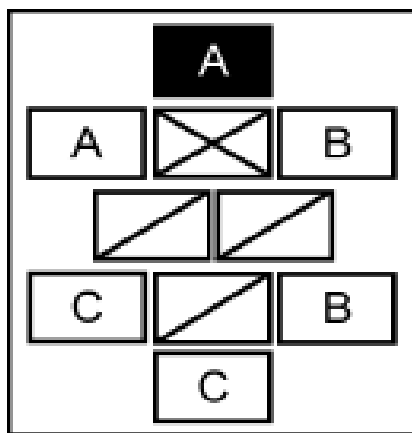

Figure 3-12. Diamond and circle Information.

6. Assembling a Squad.

- a. When assembling a squad from the line formation, the squad leader takes a position a sufficient distance to the rear of the squad and commands, “Squad Assemble.” At the same time, he raises his right hand in the air and makes a circular motion. Squad members, who hear the command, automatically come to the port arms position. The A team leader and the baseman do an about-face movement.
- b. The other squad members face toward the baseman. On the command of execution “Move,” the squad leader points to the place where he wants the squad to assemble. The A team leader double-times to the

designated spot, and the other members of the squad follow him. Team leaders fall into the file in their designated positions as they move to the AA. To assemble from a squad echelon formation, the steps are the same as a line formation.

c. To assemble from a squad wedge formation, the squad leader takes the same steps as for the line and echelon formations. B team members do a half left face, and the A team and C team members do a half right face. The C team pauses at the baseman position and allows the B team to clear the formation before moving to the AA.

d. To assemble from a squad diamond or circle formation, the squad leader takes the same steps as he would for a line formation. The A team leads the squad to the AA followed by the B team and then the C team. Teams fall into a column formation as they file back to the AA.

#### PART D - Platoon Formations (4 Squad)

1. General. Platoon headquarters should consist of the following individuals:

a. Platoon leader.

b. Platoon sergeant.

c. Radio Operator or messenger

d. When directed by the platoon leader, other persons, such as marksman, interpreters, RCA dispenser operators, and firefighters may added to or become a part of the platoon headquarters.

e. In forming all control force formations from the column, the platoon leader moves to the right of the platoon and faces them when giving his commands. He gives the hand-and-arm signal and the preparatory command. On the command of execution "Move," he points to the approximate location where he wants the platoon to form. The platoon leader pauses between the preparatory command and the command of execution to allow each squad leader to issue a preparatory command to his squad.

2. Platoon Line.

a. Command. "Platoon on Line, Move."

b. Execution. Immediately following the platoon leader's preparatory command, the squad leaders of the 1st and 4th squads command, "Follow Me." The squad leaders of the 2d and 3d squads command "Stand Fast." On the platoon leader's command of execution, the 1st and 4th squads move forward to the point designated by the platoon leader. The 1st A team member of the 1<sup>st</sup> squad is the baseman for the platoon formation. The 1st squad forms a squad line to the left of the baseman and the 4th squad forms a squad line to the right of the baseman with all lines dressed to the right. After the 1st and 4<sup>th</sup> squads have cleared the platoon, the 2d and 3d squad leaders command, "Follow Me." The 2d squad forms a squad line to the left of the 1st squad. The 3d squad forms a squad line to the right of the 4th squad. All squads dress with the 4th squad. (Figure 3-13).

3. Platoon Line Formation Assembly.

a. When assembling from the platoon line formation, the platoon leader and his HQ personnel take a

position to the rear of the platoon. He then gives the command, "Platoon Assemble," while raising his right arm and making a circular motion above his head.

b. Execution. Platoon members automatically assume the port arms position. The 1st squad leader and the baseman do an about-face movement. All other platoon members do an about-face movement toward the baseman. On the platoon leader's command of execution, he points to where he wants the platoon to assemble. He commands, "Follow Me," and moves his squad toward the AA. The 1st squad files to the baseman position, followed by the 2d squad. As the 2d squad clears the baseman position, the 4th squad leader then commands, "Follow Me," and leads his squad to the AA, followed by the 3d squad. As the 1st squad comes to a halt facing the crowd in the AA, the 2d squad assumes its position to the right of the 1st squad. As the 4th squad assembles, it dresses on the 1st squad, leaving space for the 3d squad to return to its place in the formation. Once the platoon is formed into a column formation, HQ personnel take their position in the formation. The PSG then commands, "Countercolumn, March," and moves the platoon to the rally point.

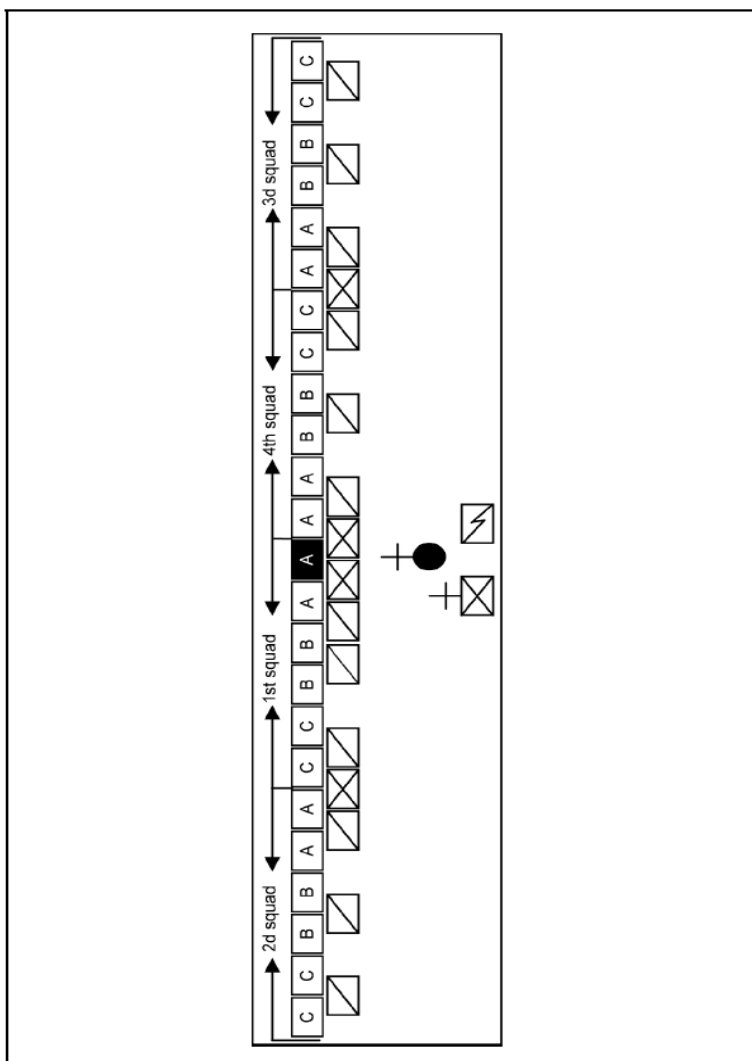

FIGURE 3-13. Platoon Line Formation With Four Squads

4. Platoon Line Formation With General Support.

a. General Support. Whenever the command for establishing a crowd control formation contains the phrase, IN SUPPORT Without Modification, it means that the support element is to remain in general support.

(1) Command. "Platoon Line, 2d and 3d Squads in Support, Move."

(2) Execution. The 1st and 4th squads execute the line, while the 2d and 3d squads remain in the column. To assemble a platoon with two squads in general support, the procedure is the same as that of the platoon line, except that the 1st and 4th squads dress on with the 2d and 3d squads. (See Figure 3-14).

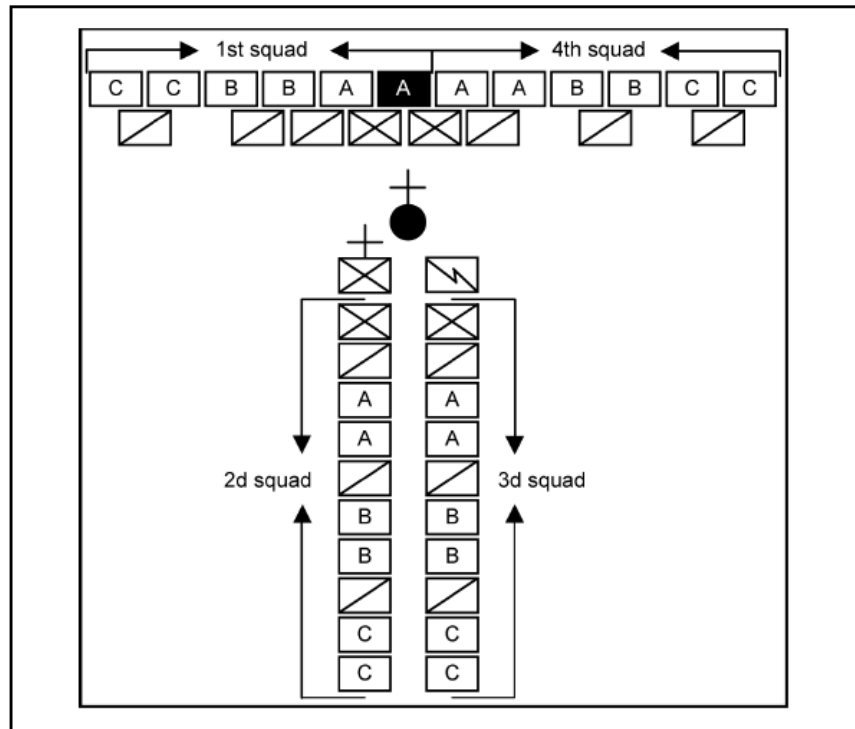

FIGURE 3-14. Platoon Line With 2d and 3d Squads in General Support.

b. Lateral Support.

(1) Command. "Platoon Line, 2d and 3d Squads in Lateral Support, Move."

(2) Execution. The 4th and 1st squads execute the line as before, and the 2d and 3d squads stand fast. After the line has been formed, the squad leaders of the 2d and 3d squads command, "Follow Me." The 2d squad forms a column behind the last man of the 1st squad. The 3d squad forms a column behind the last man of the 4th squad.

(3) Squads may be moved from general support to lateral support at any time by the platoon leader. He commands, "2d and 3d Squads, Lateral Support, Move." To have the 2d and 3d squads join the line from either support position, the platoon leader commands, "2d and 3d Squads, Extend the Line, Move." The 2d and 3d squad leaders command, "Follow Me." On the command of execution, the squads set up individual lines, closing and dressing with the existing line. To assemble the platoon from a platoon line with lateral support, the procedure is the same as that of the platoon line, except lateral support squads face forward until they move to the AA. (See Figure 3-15).



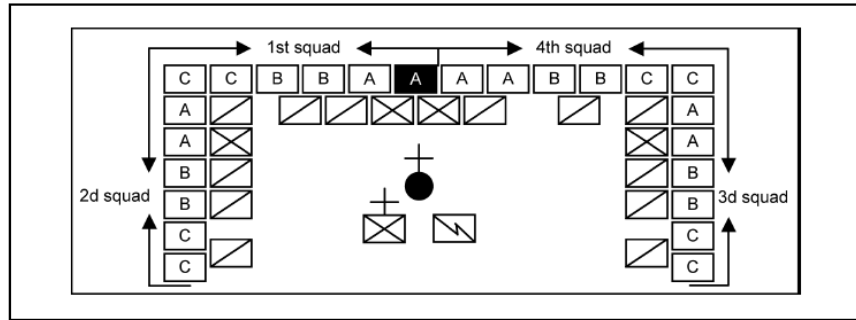

FIGURE 3-15. Platoon Line Formation With 2d and 3d Squads in Lateral Support.

c. Platoon Line Formation With Direct Support.

(1) Command. "Platoon Line, 2d and 3d Squads in Direct Support, Move."

(2) Execution. The 1st and 4th squads execute a line as before. The 2d and 3d squads execute a 2d line directly to the rear and centered on the 1st line. The members in the direct support line cover the intervals between members in the baseline. To do this, the squad and team leaders of the 1st and 4th squads must take two steps to the rear to allow space for the 2d and 3d squads to move into place. After seeing the squad and team leaders move back from the line, 2d and 3d squad leaders command, "Follow Me," and lead their squads into position. (see Figure 3-16)

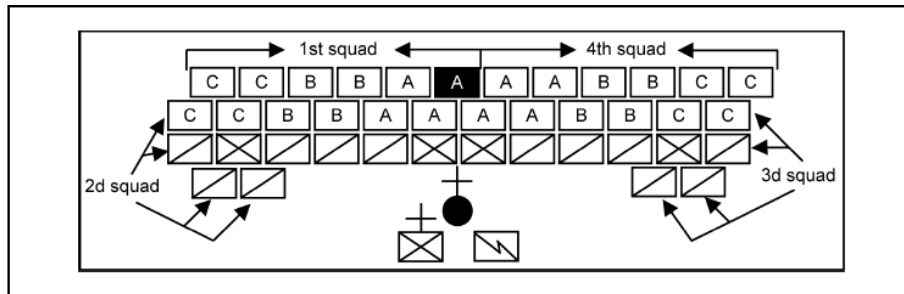

FIGURE 3-16. Platoon Line Formation With 2d and 3d Squads in Direct Support

d. Platoon Line Formation With One Support Squad.

(1) Command. "Platoon Line, 3d Squad in Support, Move."

(2) Execution. The 1st squad moves out and executes a squad line. The 2d and 4th squads form a line on the side of the left and right sides of the 1st squad. The 3d squad remains in column formation. The support squad may be used in lateral support on one or both sides of the formation or in direct support of any segment of the formation. To assemble the platoon, the procedure is the same as that of a platoon line, except that all squads dress with the 3d squad.

5. Platoon Echelon Right and Left Formations.

a. Command. "Platoon Echelon Right, Move."

b. Execution. After the platoon leader's preparatory command, the squad leader of the 1st squad commands, "Follow Me." The squad leaders of the 2d, 3d, and 4th squads command, "Stand Fast." On the command of execution, the 1st squad moves out and executes an echelon right at the location designated by the platoon leader. As each squad clears the column, the next successive squad moves out and extends the echelon that has been formed. To assemble the platoon, the procedure is the same as that of a platoon line,

except that all squads file back in order.

c. The command for forming a platoon echelon left formation is “Platoon Echelon Left, Move.” The platoon echelon left is formed in the same manner as the echelon right, but in reverse order (see Figure 3-17). To assemble the platoon, the procedure is the same as that of an echelon right. (See Figures 3-18, 3-19, and 3-20, for examples of echelon formations with support.)

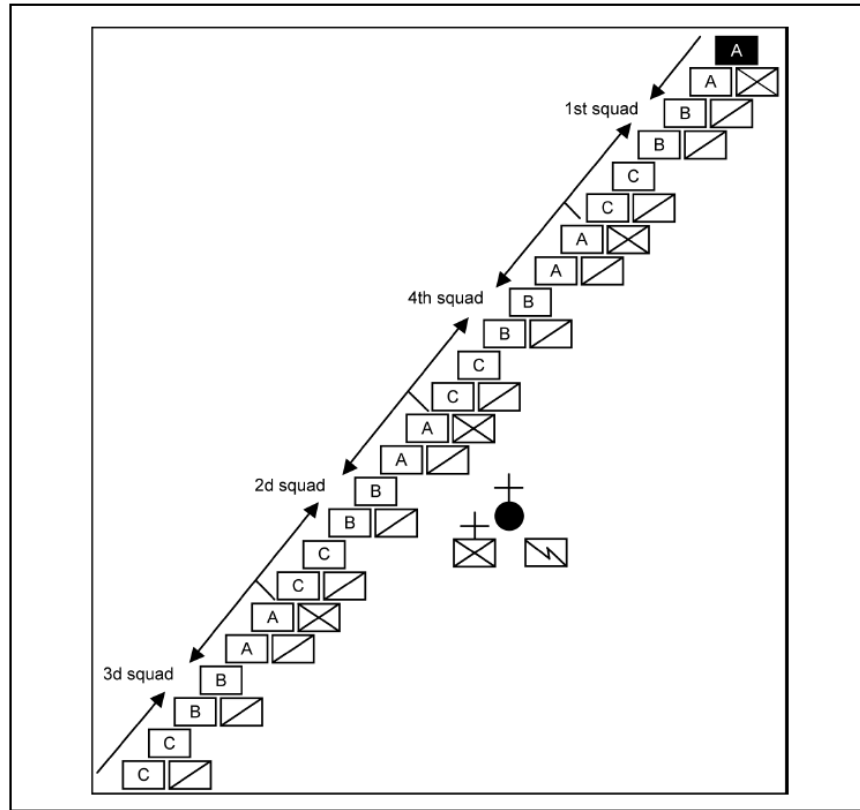

FIGURE 3-17. Platoon Echelon Left Formation With Four Squads

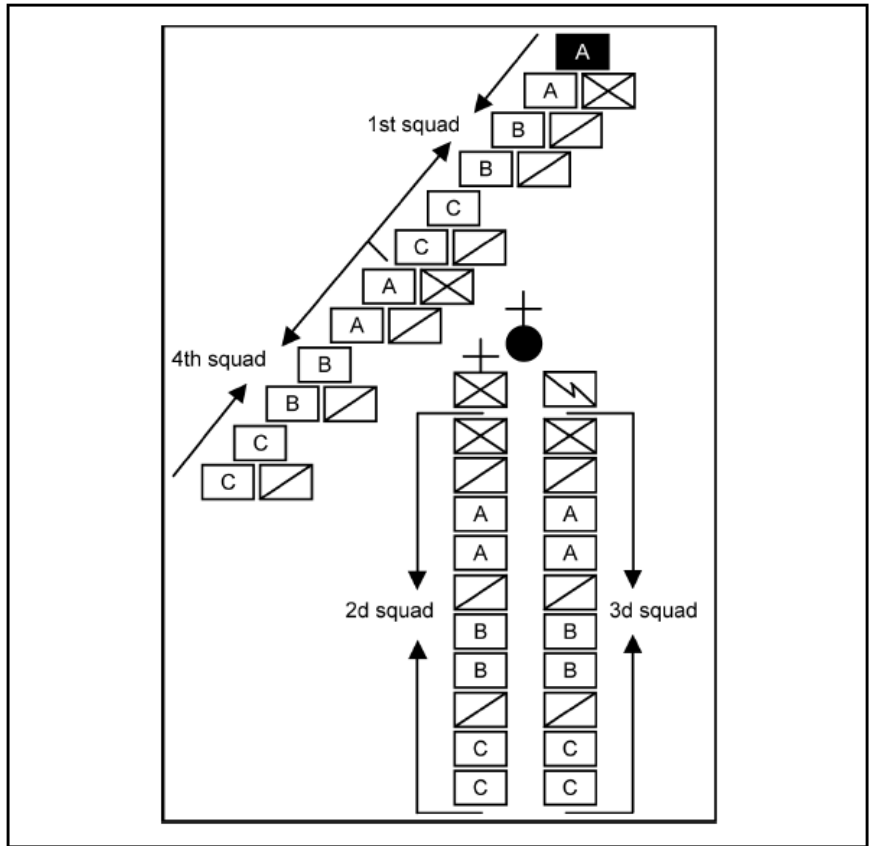

FIGURE 3-18. Platoon Echelon Left Formation With 2d and 3d Squads in General Support

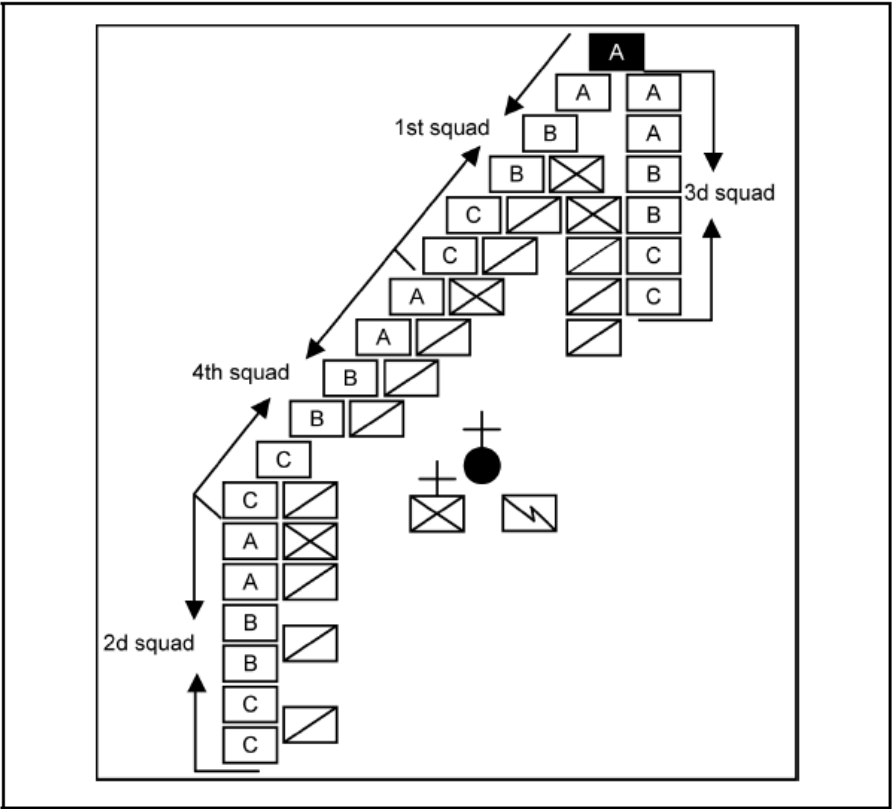

FIGURE 3-19. Platoon Echelon Left Formation With 2d Squad in Lateral Support.

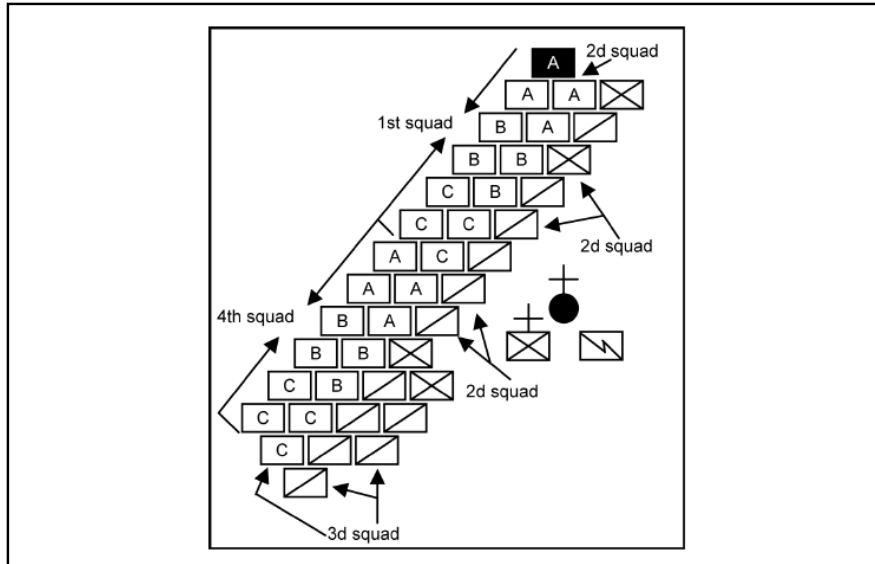

FIGURE 3-20. Platoon Echelon Left Formation With 2d and 3d Squads in Direct Support.

6. Platoon Wedge.

a. Command. "Platoon wedge, Move."

b. Execution. After the platoon leader's preparatory command, the 1st and 4th squad leaders command, "Follow Me." At the same time, the 2d and 3d squad leaders command, "Stand Fast." On the platoon leader's command of execution, the 1st and 4th squads move directly to the front. When the last members of the 1st and 4th squads clear the 2d and 3d squads, the 2d and 3d squad leaders command, "Follow Me," and move out to the left and right. The 1st squad executes an echelon left on the baseman and the 4th squad executes an echelon right. The 2d squad forms an echelon left on the last man of the 1st squad. The 3d squad forms an echelon right on the last man of the 4th squad. This completes the wedge formation. (see Figure 3-21)

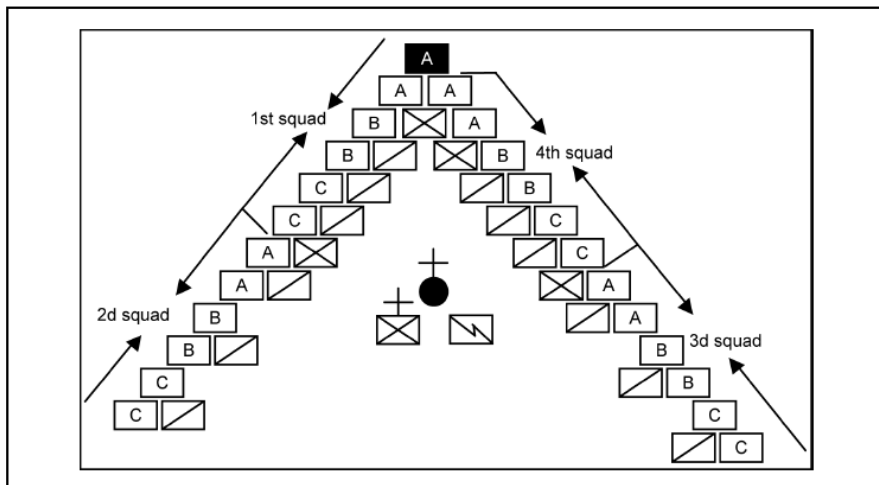

FIGURE 3-21. Platoon Wedge Formation With Four Squads.

7. Platoon Wedge Formation With General Support.

a. General Support.

(1) Command. "Platoon Wedge, 2d and 3d Squads in Support, Move."

(2) Execution. The command for forming a platoon wedge formation with two squads in support is "Platoon Wedge, 2d and 3d Squads in Support, Move." The 1st and 4th squads execute the wedge while the 2d and 3d squads remain in column formation. (see FIGURE 3-22)

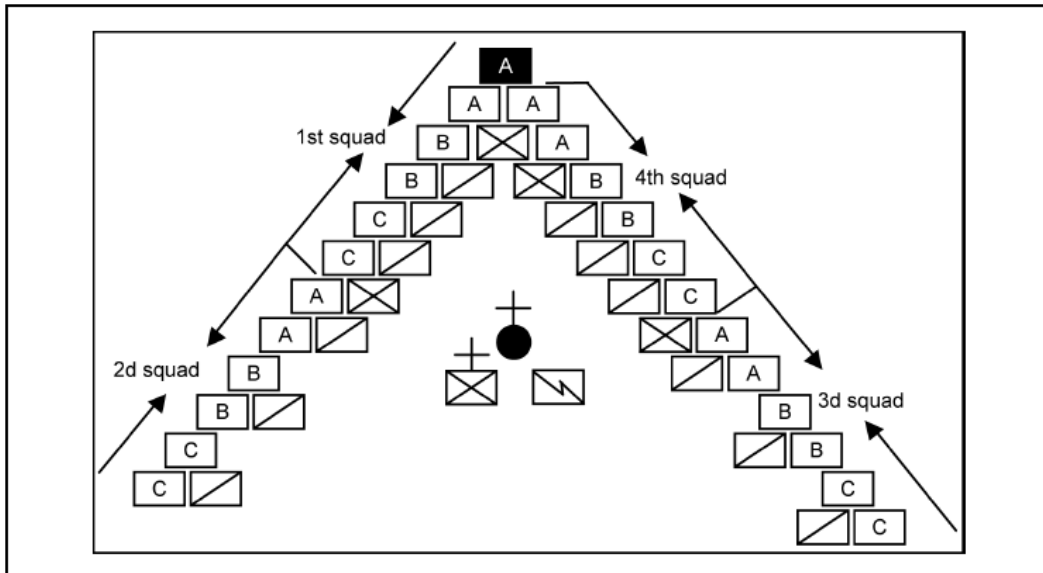

FIGURE 3-22. Platoon Wedge Formation With Four Squads

b. Platoon Wedge Formation With Lateral Support.

(1) Command. Platoon Wedge, 2d and 3d Squads in Lateral Support, Move."

(2) Execution. The 1st and 4th squads execute the wedge while the 2d and 3d squads stand fast. After the 1st and 4th squads have cleared the column, the 2d and 3d squad leaders command, "Follow Me," and move out to the left and right. The 2d squad forms a column formation behind the last man of the 1st squad. The 3d squad forms a column formation behind the last man of the 4th squad. (see Figure 3-23)

(c) To move the 2d and 3d squads from general to lateral support, the platoon leader commands, "2d and 3d Squads, Lateral Support, Move." To have the 2d and 3d squads join the wedge from general or lateral support, the platoon leader commands, "2d and 3d Squads, Extend the Wedge, Move." The 2d and 3d squad leaders command, "Follow Me," and move out to the left and right to extend the wedge on the 1st and 4th squads.

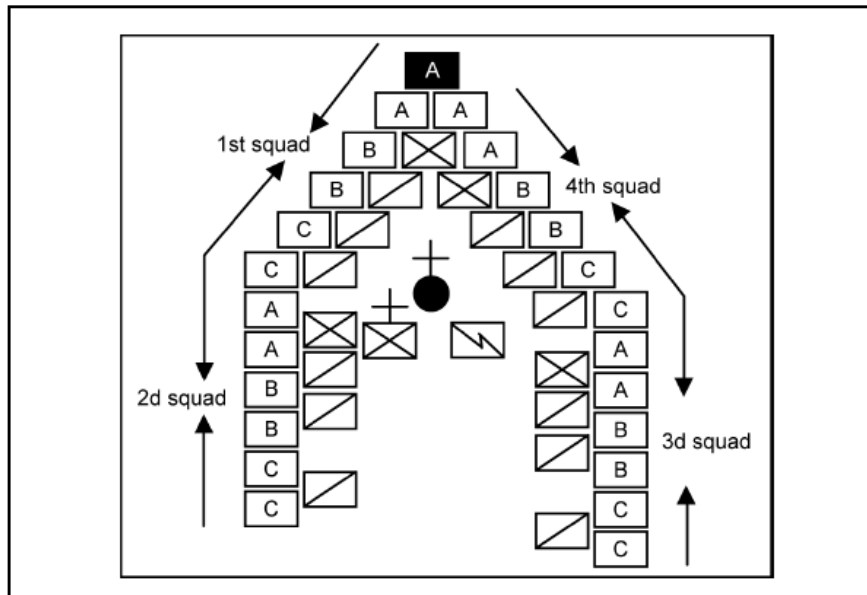

Figure 3-23. Platoon Wedge Formation With 2d and 3d Squads in Lateral Support

c. Platoon Wedge Formation With Direct Support.

(1) Command. Platoon Wedge, 2d and 3d Squads in Direct Support, Move."

(2) Execution. The command for forming a platoon wedge with two squads in direct support is "Platoon Wedge, 2d and 3d Squads in Direct Support, Move." The 1st and 4th squads execute a wedge. The 2d and 3d squads execute a wedge and close in on the leading wedge. The members in the supporting wedge cover the intervals between members in the leading wedge. To do this, the squad and team leaders of the 1st and 4th squads must take two steps to the rear to allow space for the 2d and 3d squads to move into place. After seeing the squad and team leaders move back from the line, the 2d and 3d squad leaders command, "Follow Me," and lead their squads into position. To move the 2d and 3d squads back to general support, the platoon leader commands, "2d and 3d Squads Support, Move." Then the 2d and 3d squads move to their general support positions. (see Figure 3-24)

(3) To assemble a platoon from a platoon wedge with direct support, the procedure is the same as that of a platoon wedge, except that the 2d squad assembles first, followed by the 3d, 1st, and 4th squads.

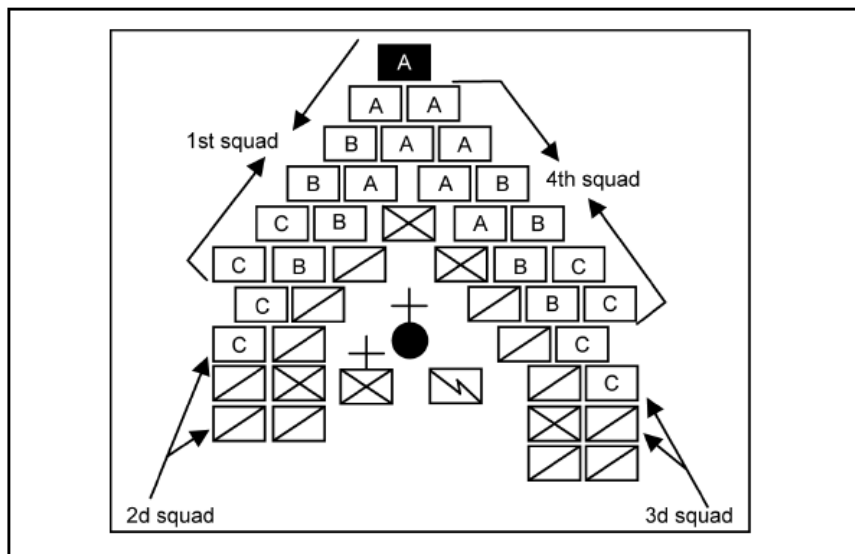

## FIGURE 3-24. Platoon Wedge Formation With 2d and 3d Squads in Direct Support

### d. Platoon Wedge Formation With One Support Squad.

(1) Command. Platoon Wedge, 3d Squad in Support, Move."

(2) Execution. The 1st squad moves out and executes a squad wedge. The 2d and 4th squads form echelons left and right on the 1st squad. The 3d squad remains in the column formation.

### 8. Platoon Diamond and Circle Formations.

a. Command. "Platoon Diamond (or Circle), Move."

b. Execution. On the command of execution, the 1st squad leader moves the baseman to the location indicated by the squad leader. The baseman becomes the 12 o'clock position. The 1st squad lines up to the left of the baseman covering the 9 to 12 o'clock positions. The 4th squad aligns themselves to the right of the baseman covering the 12 to 3 o'clock positions. The 3d squad aligns itself covering the 3 to 6 o'clock positions. The 2d squad aligns itself covering the 6 to 9 o'clock positions.

c. To assemble a platoon from a platoon diamond or circle formation, the HQ element uses the same procedures as that of a line formation. The 1st squad leads the platoon back to the AA followed by the 2d, 3d, and 4th squads. The squads fall into a column formation as they file back to the AA.

### 9. Assembling a Platoon.

a. Command. "Platoon Assemble, Move."

b. Execution. The platoon leader moves out to the rear of his platoon. As he gives his preparatory command, he points to the location at which the platoon is to assemble. If he does not point, the platoon assembles directly in front of its present location. Immediately following the platoon leader's preparatory command, the squad leaders move to the head of their respective squads and command FOLLOW ME. At the command of execution, the squads follow their respective squad leaders to their appropriate positions to form a platoon column.

10. Relief Elements in Place. During crowd control operations, the platoon leader may rotate his squads to give them a rest. He is not limited to using only those squads specified in the preceding examples as the lead elements of the formations. He can replace the base elements by commanding direct support to the 1st squad and then directing the 1st squad into general support. The support element (the 2d squad) then passes through the 1st squad. Once, the 2d squad is formed directly behind the 1st squad, the 1st squad leader commands, "Right Face." The members of the 1st squad do a right-face movement and the 2d squad steps quickly through the 1st squad and forms the base formation. The 1st squad leader then commands, "Follow Me," and leads his squad to the general support position. This procedure is often necessary when protective masks are used and chemical irritants employed. The 1st squad then replaces the 3d squad in the same manner. Platoons participating in company operations are relieved in the same manner.

### 11. Three –Squad Platoon Formations.

a. General.

(1) Platoon headquarters should consist of the following individuals:

- (a) Platoon Leader.
- (b) Platoon Sergeant.
- (c) Radio Operator or messenger.

(2) When directed by the platoon leader, other persons, such as marksman, interpreters, RCA dispenser operators, and firefighters may be added to or become a part of the platoon headquarters.

(3) In forming all control force formations from the column, the platoon leader moves to the right of the platoon and faces them when giving his commands. He gives the hand-and-arm signal and the preparatory command. On the command of execution "Move," he points to the approximate location where he wants the platoon to form. The platoon leader pauses between the preparatory command and the command of execution to allow each squad leader to issue a preparatory command to his squad.

#### b. Platoon Line Formation.

(1) Command. "Platoon on Line, Move."

(2) Execution. Immediately following the platoon leader's preparatory command, the squad leaders of the 1st and 3d squads give the command, "Follow Me." The leader of the 2d squad gives the command, "Stand Fast." On the platoon leader's command of execution, the 1st and 3d squads move forward to the point designated by the platoon leader. The 1st team member of the 1st squad is the baseman for the platoon formation. The 1st squad forms a squad line to the left of the baseman while the 3d squad forms a squad line to the right of the baseman and dresses with the 1st squad. After the 1st and 3d squads have cleared the platoon, the 2d squad leader gives the command, "Follow Me." The 2d squad splits and the A and B teams form a line to the right of the 3d squad. (see Figure 3-25)

(3) Assembling from a platoon Line Formation. When assembling the platoon from the platoon line formation, the platoon leader and his HQ personnel take a position to the rear of the platoon. He then gives the command, "Platoon Assemble," while raising his right arm and making a circular motion above his head. Platoon members automatically assume the port arms position. The 1st squad leader and the baseman do an about face. The 3d squad leader moves to the head of his squad. All other members do an about-face movement toward the baseman. On the platoon leader's command of execution, the platoon leader points to where he wants the platoon to assemble. The 1st squad leader gives the command, "Follow Me," and moves his squad toward the AA. The squad moves to make a single file line to the baseman position followed by the C team of the 2d squad. As the 1st squad clears the baseman position, the 2d squad leader comes to a halt at the baseman position. The 3d squad leader gives the command, "Follow Me," and leads his squad to the AA followed by the A and B teams of the 2d squad. The A team leader of the 2d squad comes to a halt at the baseman position. Once the 3d squad has cleared the baseman position, the 2d squad leader gives the command, "Follow Me," and leads his squad to the AA. The 2d squad reassembles into their original column formation as they move to the AA. As the 1st squad comes to a halt (facing the crowd) in the AA, the 3d squad dresses with the 1st squad and leaves space for the 2d squad to return to its place in the formation. Once the platoon is formed into a column formation, HQ personnel take their position in the formation. The PSG then gives the command, "Counter-column March," and moves the platoon to the rally point.



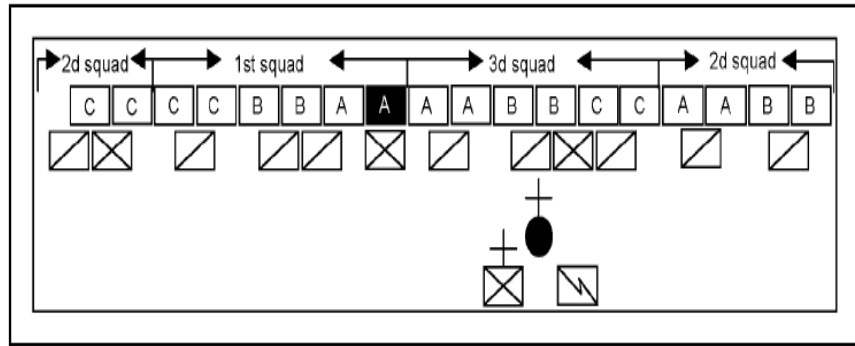

Figure 3-25. Platoon Line Formation

c. Platoon Line Formation with General Support.

(1) Command. “Platoon Line, 2d Squads in Support, Move.”

(2) Execution. The 1st and 3d squads of the platoon line with general support execute the line, while the 2d squad remains in the column. To assemble a platoon with a squad in general support, the procedure is the same as the platoon line, except that the 1st and 3d squads dress with the 2d squad.

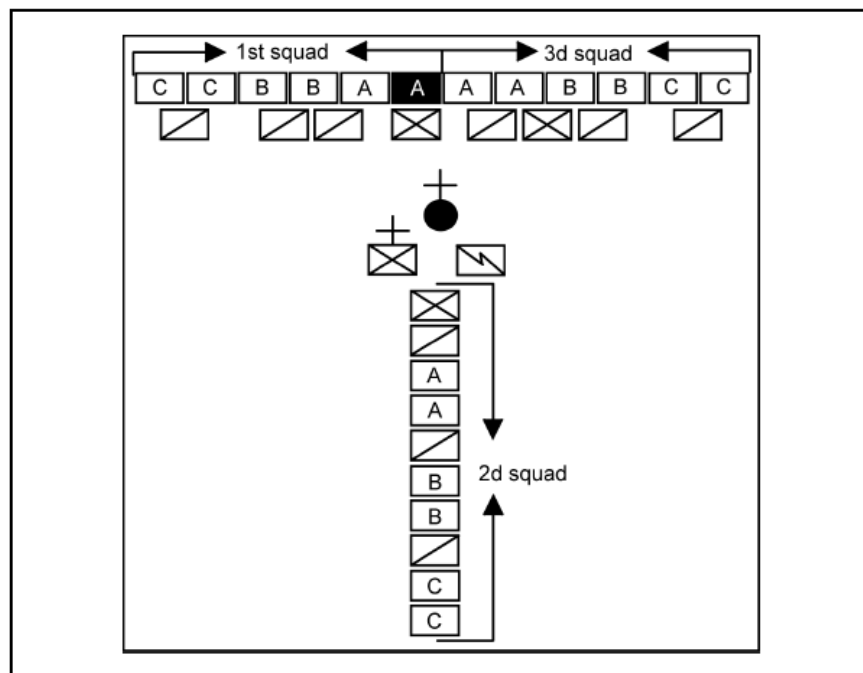

FIGURE 3-26. Platoon Line Formation With General Support

d. Platoon Line Formation With Lateral Support.

(1) Command. “Platoon Line, 2d Squad in Lateral Support, Move.”

(2) Execution. The 1st and 3d squads execute the line as before, and the 2d squad stands fast. After the line has been formed, the 2d squad leader gives the command, “Follow Me.” The A and B teams move to the right flank while the squad leader and the C team move to the left flank of the formation. The 2d squad forms columns behind the last men on the line formation. If no direction is given, the 2d squad splits to cover both flanks. A squad may be used to cover one flank by giving the command, “2d Squad Right (or Left) Lateral Support” (see Figure 3-27).

(3) The 2d squad may be moved from general to lateral support at any time by the platoon leader. The platoon leader commands, "2d Squad, Lateral Support, Move." To have the 2d squad join the line from either support position, the platoon leader commands, "2d Squad, Extend the Line, Move." The 2d squad leader commands "Follow Me." On the command of execution, the squads set up individual lines, closing and dressing on the existing line. To assemble the platoon from a platoon

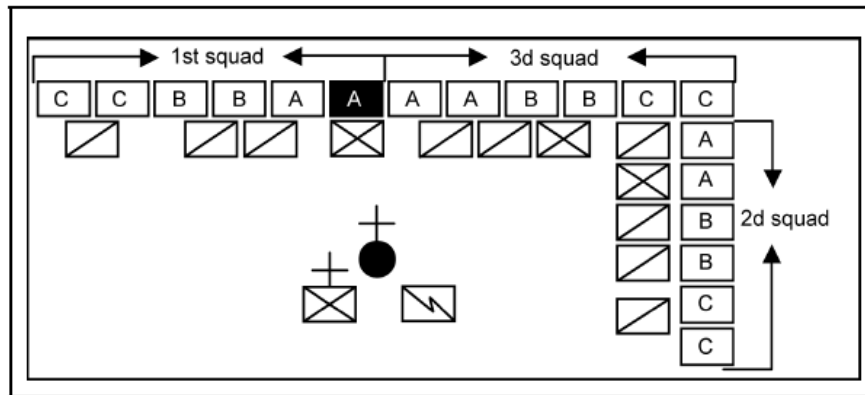

FIGURE 3-27 Platoon Line Formation With Lateral Support (Right)

e. Platoon Line Formation With Direct Support.

(1) Command. "Platoon Line, 2d Squad in Direct Support, Move."

(2) Execution. The 1st and 3d squads execute a line as before. The 2d squad executes a squad line directly to the rear and centered on the 1st line. The men in the supporting line cover the intervals between the men in the 1st line. To do this, the squad and team leaders of the 1st and 3d squads must take two steps to the rear to allow space for the 2d squad to move into place. After seeing the squad and team leader move back from the line, the 2d squad leader commands, "Follow Me," and leads his squad into position (see Figure 3-28).

(3) To assemble a platoon with direct support, the procedure is the same as the platoon line, except that the 2d squad moves to the AA first. To assemble the support squads from any position to general support, the platoon leader commands, "2d Squad in Support, Move." The 2d squad then returns to a column behind the line formed by the other two squads.

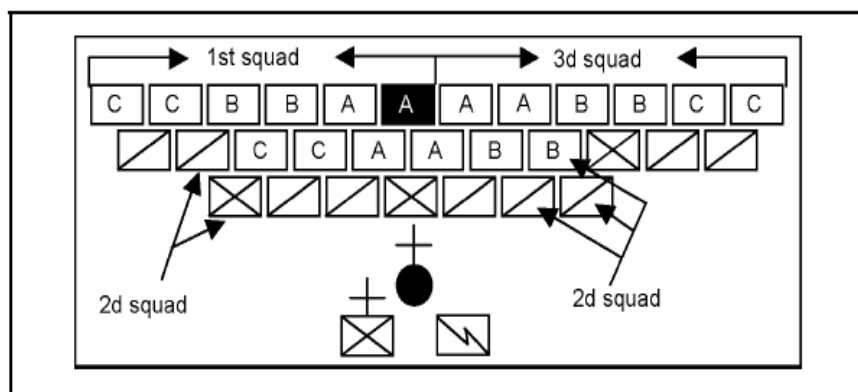

Figure 3-28. Platoon Line Formation With Direct Support

f. Platoon Echelon Right and Left Formations.

(1) Command. "Platoon Echelon Right, Move."

(2) Execution. After the platoon leader's preparatory command, the squad leader of the 1st squad commands, "Follow Me." The squad leaders of the 2d and 3d squads command, "Stand Fast." On the command of execution, the 1st squad moves out and executes an echelon right at the location designated by the platoon leader. As the 1st squad clears the column, the 3d and 2d squads extend the echelon. The 2d squad performs support to this formation in the same ways it supports a line formation.

(3) The command for forming a platoon echelon left is "Platoon Echelon Left, Move." The platoon echelon right is formed in the same manner as the echelon left. (Figures 3-29, 3-30 and 3-31 show support formations in a left echelon).

(4) Assembly. To assemble the platoon, the commander takes his position to the rear of the formation with the platoon HQ. On the preparatory command, "Platoon Assemble," the 1st squad leader does an about-face movement while all other members assume the port arms position and face the baseman. On the command, "Move," the 1st squad moves first, followed by the 3d and 2d squads. Each squad dresses with the 1st squad as it reaches the AA. The assembly of the echelon right formation is the same as the echelon left.

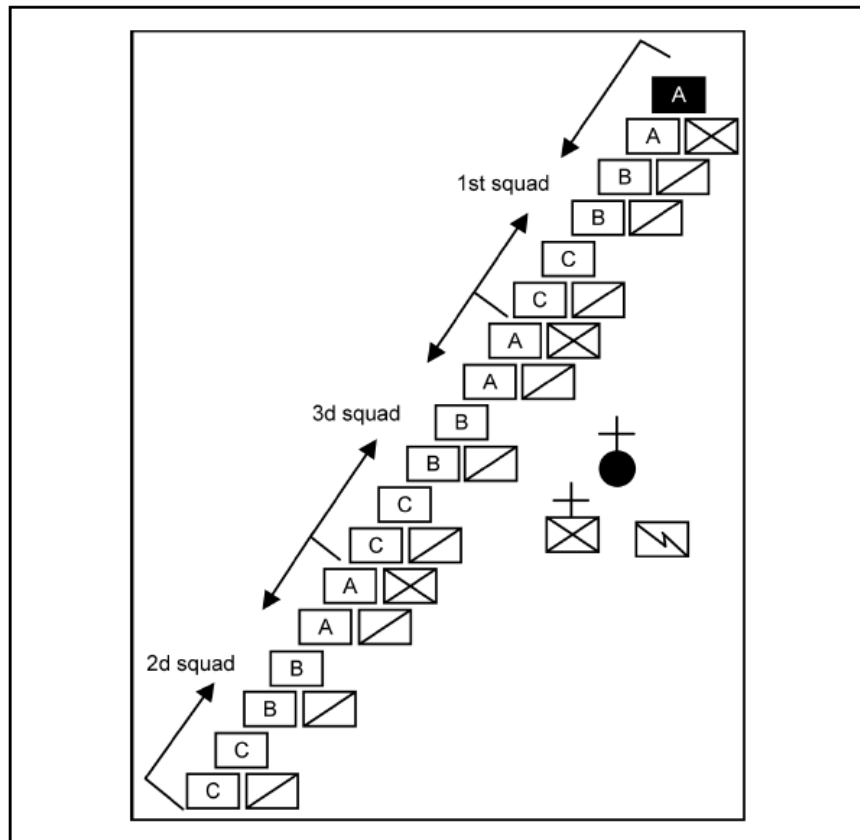

Figure 3-29. Platoon Echelon Left Formation

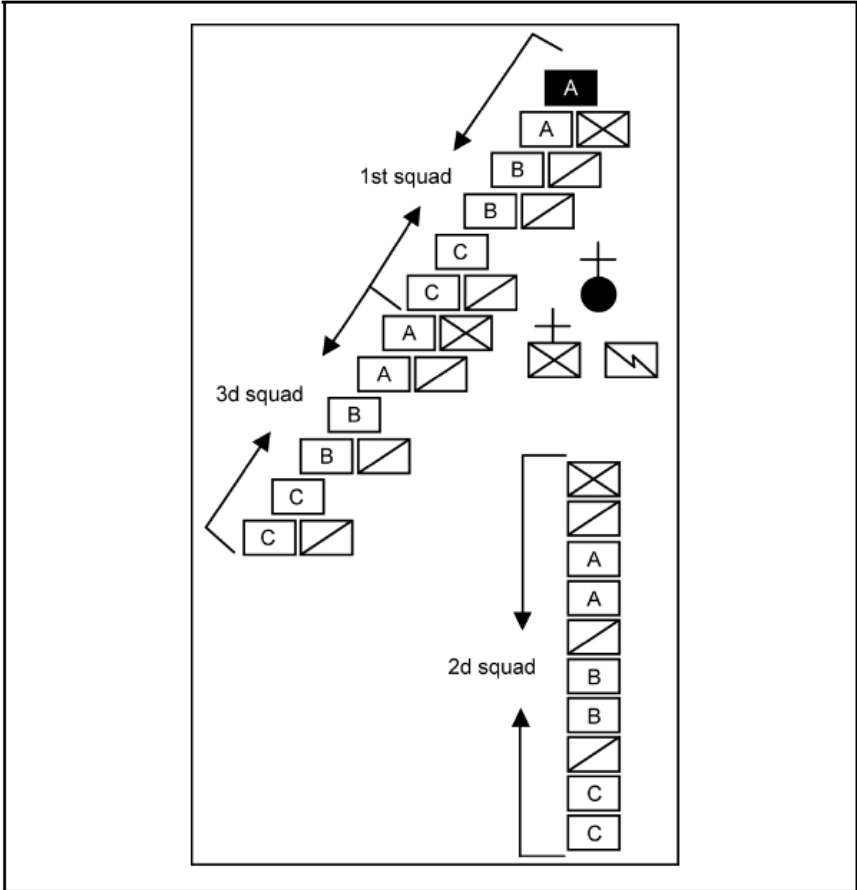

Figure 3-30 Platoon Echelon Left Formation with 2ed Squad in General Support

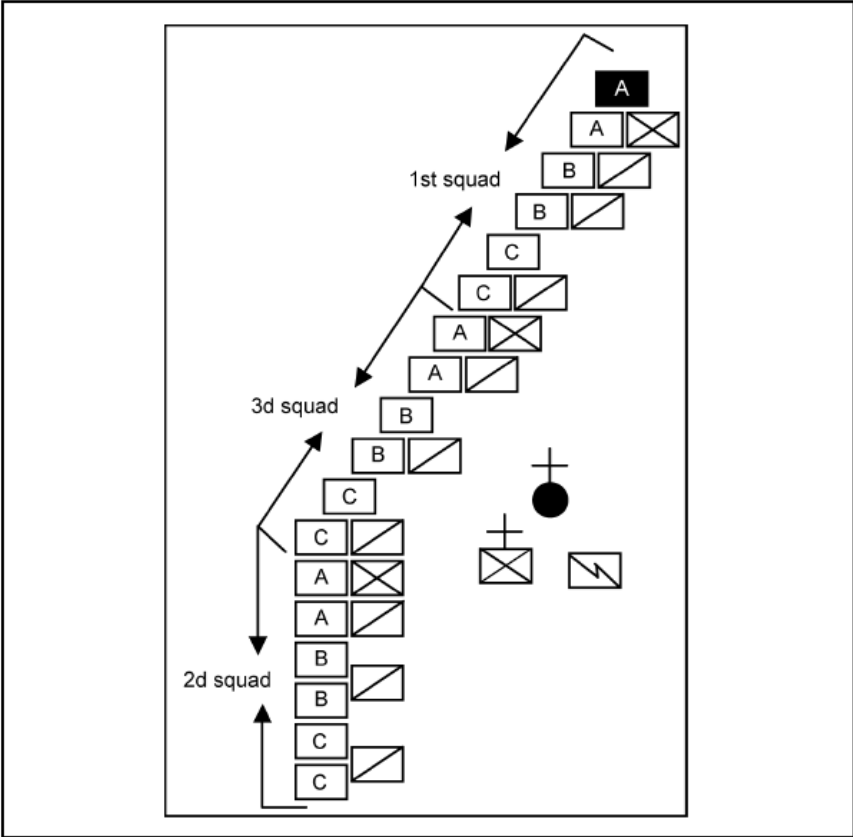

Figure 3-31. Platoon Echelon Left Formation With 2d Squad in Lateral Support.

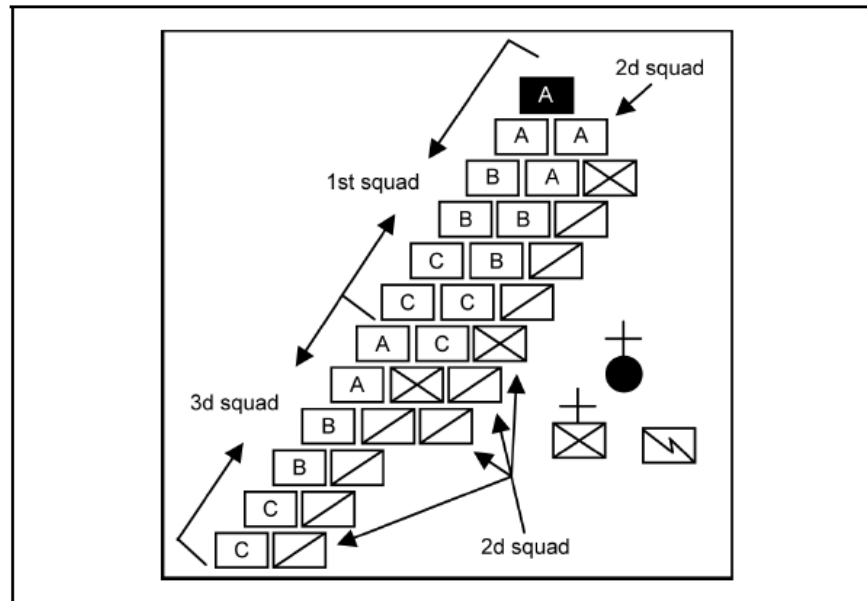

Figure 3-32. Platoon Left with 2d squad in Direct Support.

g. Platoon Wedge Formation.

(1) Command. "Platoon Wedge, Move."

(2) Execution. After the platoon leader's preparatory command, the squad leaders of the 1st and 3d squads command, "Follow Me." At the same time, the 2d squad leader commands, "Stand Fast." On the platoon leader's command of execution, the 1st and 4th squads move directly to the front. The 1st squad executes an echelon left on the baseman while the 3d squad executes an echelon right. When the last man of the 1st and 4th squads clear the 2d squad, the 2d squad leader commands, "Follow Me," and moves out to the left and right. The 2d squad splits and the A and B teams go to the right and the C team goes to the left to extend the formation (see Figure 3-33).

(3) Assembly of the wedge formation is the same as the platoon line.

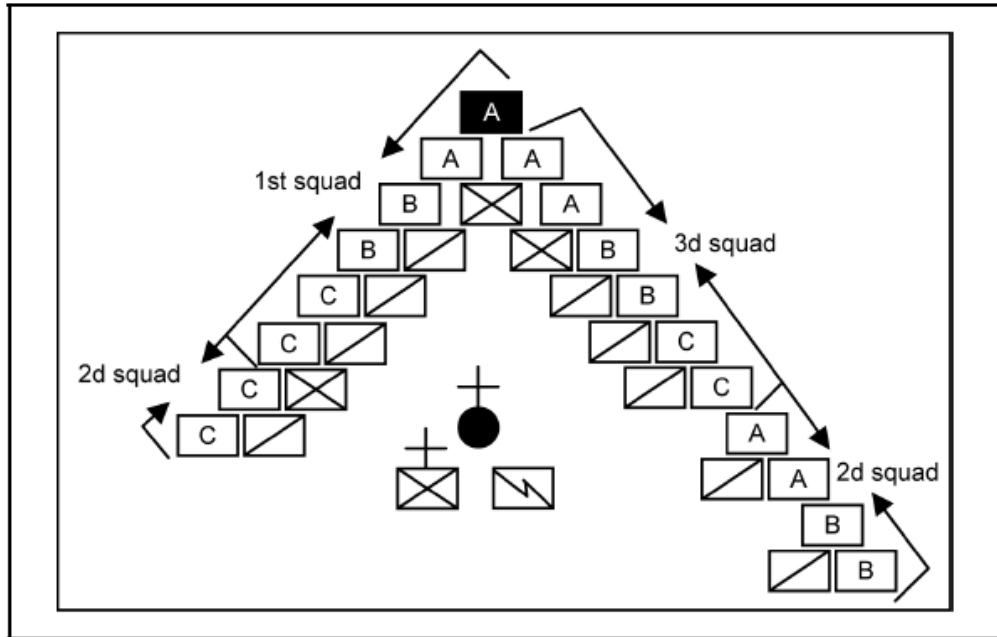

Figure 3-33. Platoon Wedge Formation

h. Platoon wedge Formation with General Support.

(1) Command. "Platoon wedge, 2d Squad in Support, Move."

(2) Execution. The 1<sup>st</sup> and 3d squads execute the wedge while 2d squad remains in a column formation (see Figure 3-34)

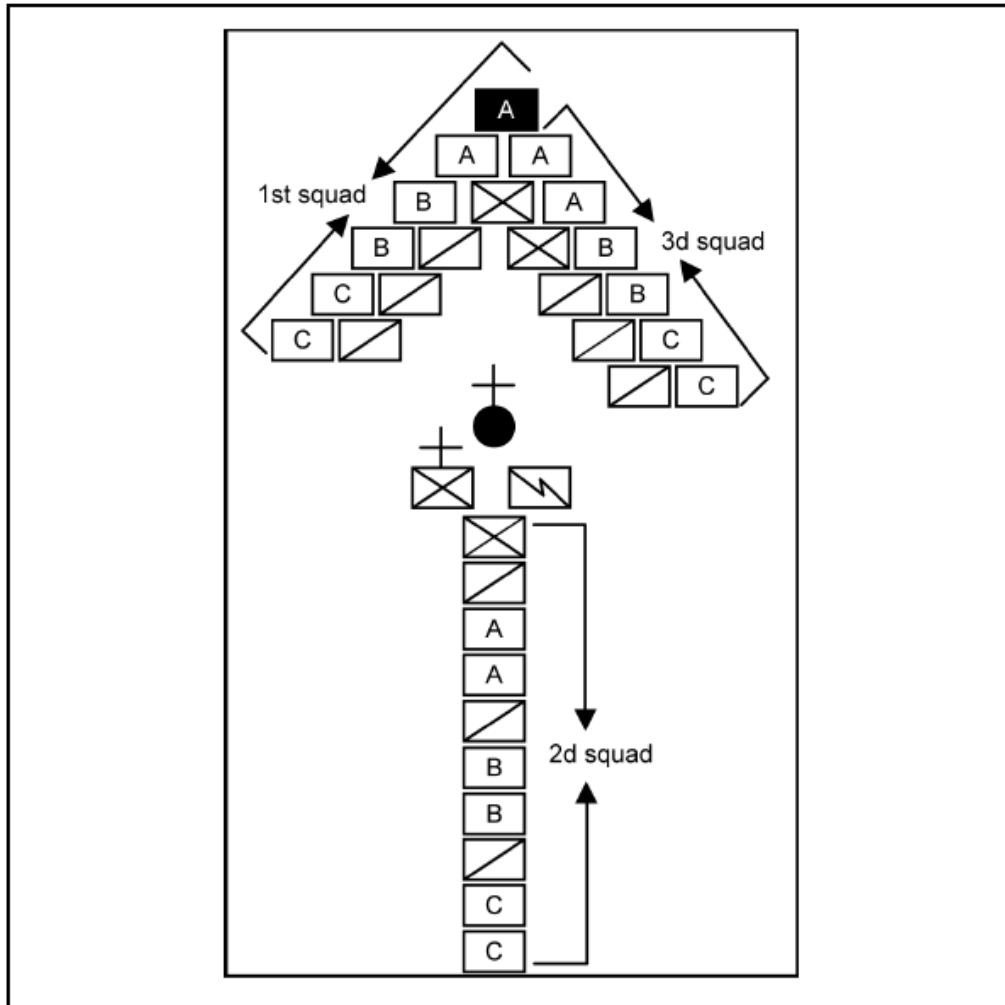

Figure 3-34. Platoon wedge Formation with 2d Squad in General Support.

i. Platoon Wedge Formation with Lateral Support.

(1) Command. "Platoon Wedge, 2d Squad in Lateral Support, Move."

(2) Execution. The 1st and 3d squads execute the wedge while the 2d squad stands fast. After the 1st and 3d squads have cleared the column, the 2d squad leader commands, "Follow Me." If no direction is given, the 2d squad splits to cover both flanks. A squad may be used to cover one flank by commanding, "2d Squad Right (or Left) Lateral Support" (see Figures 3-35 and 3-36).

(3) To move the 2d squad from general support to lateral support, the platoon leader commands, "2d Squad, Lateral Support, Move." To have the 2d squad join the wedge from general or lateral support, the platoon leader commands, "2d Squad, Extend the Wedge, Move." To extend the wedge, the 2d squad splits and the teams move to the left and right, respectively.

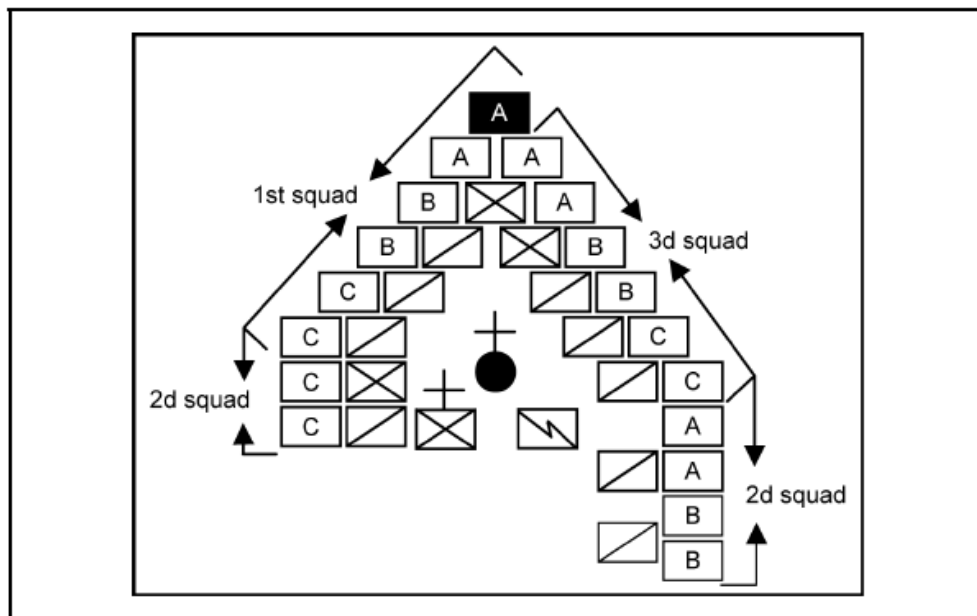

Figure 3-35. Platoon wedge Formation with 2d Squad in Lateral Support

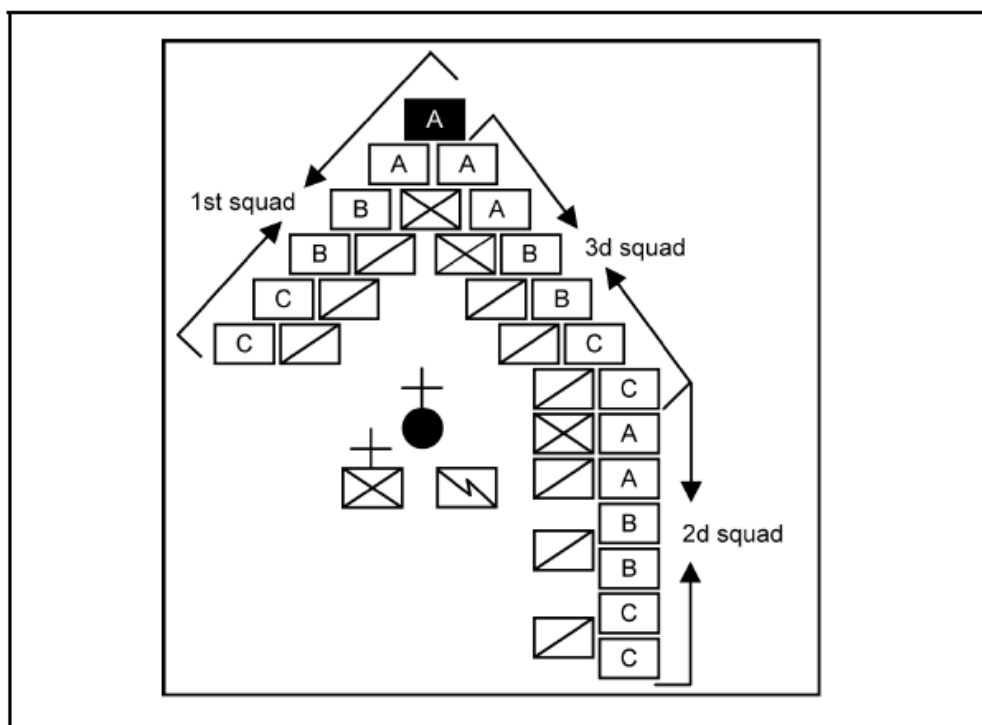

Figure 3-36. Platoon Wedge Formation with 2d squad in Right Lateral Support

j. Platoon Wedge formation With Direct Support.

(1) Command. “Platoon Wedge, 2d Squad in Direct Support, Move.”

(2) Execution. The 1st and 3d squads execute a wedge. The 2d squad waits for the squad and/or team leaders to move to the rear, as in the line formation, before executing a wedge directly behind and centered on the main formation. The individuals in the supporting wedge cover the intervals between



individuals in the leading wedge (see Figure 3-37).

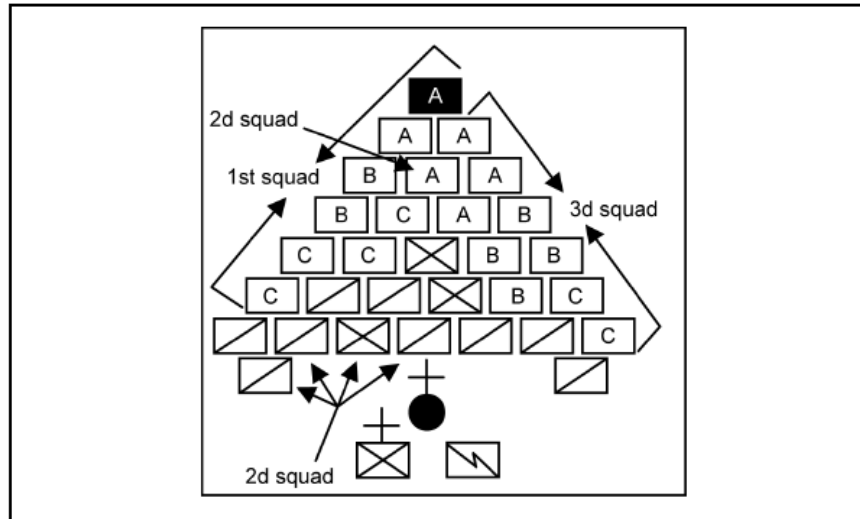

Figure 3-37. Platoon Wedge Formation with 2d Squad in Direct Support.

k. Platoon Diamond and Circle Formations.

(1) Command. “Platoon Diamond (or Circle), Move.”

(2) Execution. On the command of execution, the 1<sup>st</sup> squad leader moves the baseman to the place indicated by the squad leader. The baseman becomes the 12 o’clock position while the 1st squad lines up to the left of the baseman covering the 8 to 12 o’clock positions. The 3d squad aligns itself to the right of the baseman, covering the 12 to 4 o’clock positions and the 2d squad aligns itself, covering the 4 to 8 o’clock positions (see Figures 3-38 and 3-39).

(3) To assemble from a platoon diamond or circle formation, the HQ element takes the same steps as that of a line formation. The 1st squad leads the platoon back to the AA followed by the 2d and 3d squads. Squads fall into a column formation as they file back to the AA.

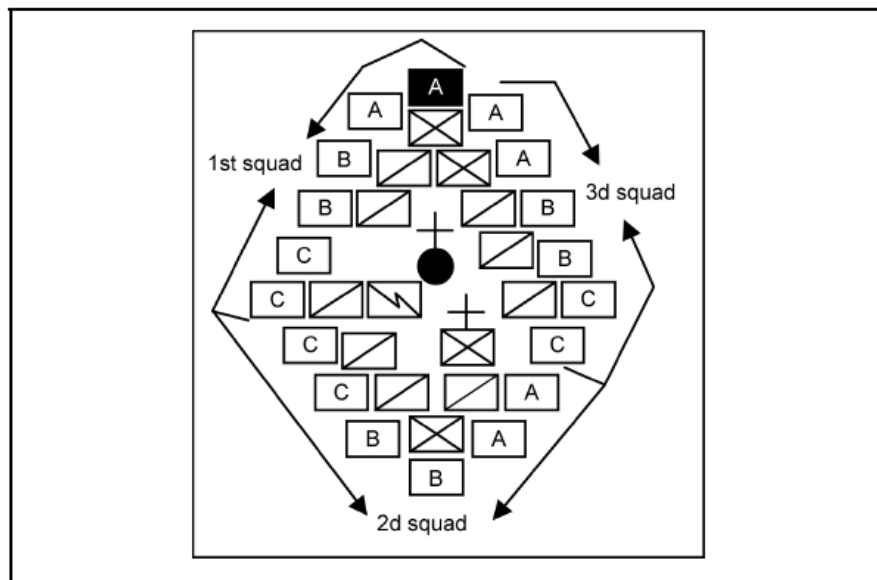

Figure 3-38. Platoon Diamond Formation.

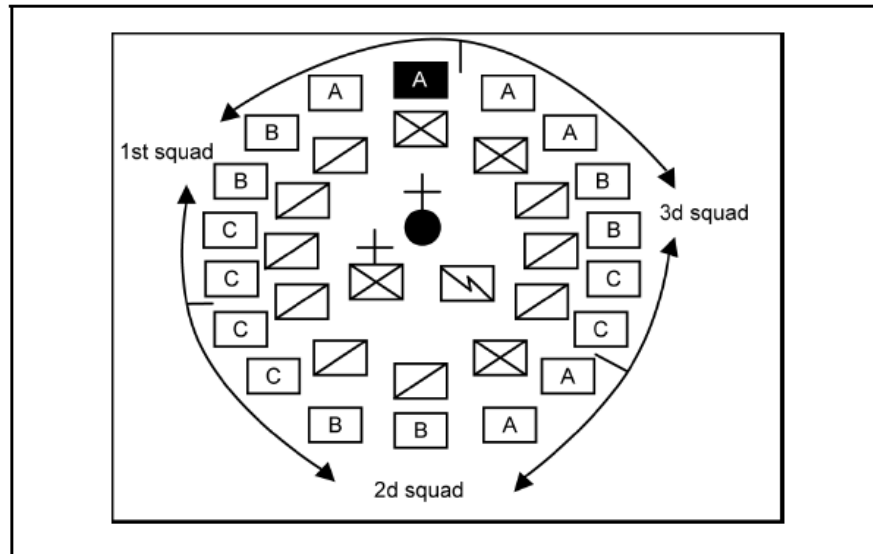

Figure 3-39. Platoon Circle Formation.

1. Assembling a Platoon. A 3-squad platoon is assembled in the same manner as a 4-squad platoon.

#### PART E - Company Formations

##### 1. Company Headquarters.

a. Personnel. The company commander may use as many personnel as needed for his headquarters; however, it is advantageous to use as few as possible. Personnel not in formation and not with the company commander may be used to secure vehicles, or they may remain at the unit's administrative area. Minimum personnel to accompany the company commander should be a messenger (radio operator) and a selected marksman.

b. Equipment. The company commander should have the following equipment:

- (1) Communications to maintain contact within his unit and with next higher headquarters.
- (2) Sufficient transportation to keep an adequate amount of supplies available, such as crowd control agent munitions.
- (3) Loudspeaker or other voice amplifying equipment.

2. Designating Locations of Formations. When the company commander orders his company into crowd control formations from the column, he moves out to the left or right near the head of the column, where he can be seen by his platoon leaders, and faces the company. As he gives his preparatory command, he points to the approximate location for the formation. If he does not indicate a location, the company forms immediately to the front of the leading platoon.

##### 3. Company Line In-Depth.

- a. Command. "Company Line in Depth, Move."
- b. Execution. After the company commander's preparatory command, each platoon leader gives the command, "Platoon Line." The squad leaders follow with their commands to their squads to form the platoon line. ON the command of execution, each platoon establishes a platoon line immediately to its front. (see Figure 3-40)
- c. If the 3d platoon is called on to support the company line, it moves forward and takes up a position directly behind the 2d platoon in the same manner. Platoon leaders and PSGs help each other in controlling the company.

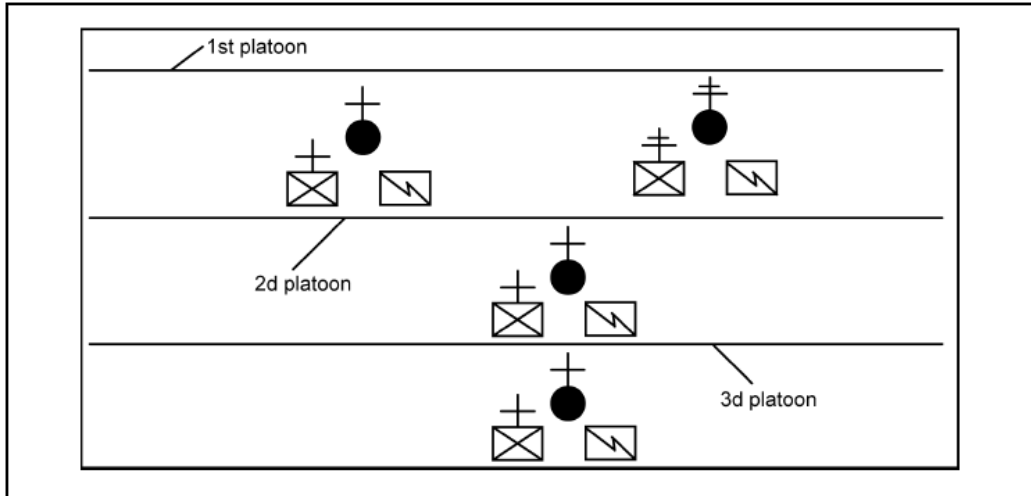

FIGURE 3-40. Company Line in Depth Formation.

4. Company Line in Mass.

- a. Command. "Company Line in Mass, Move."
- b. Execution. The company line in mass is the same as a company line with both platoons in direct support. Instead of forming it in stages, the company commander indicates his desire for this formation in his initial command. The platoons each form a line and the 2d and 3d platoons close on the 1st platoon without further command. (see Figure 3-41)

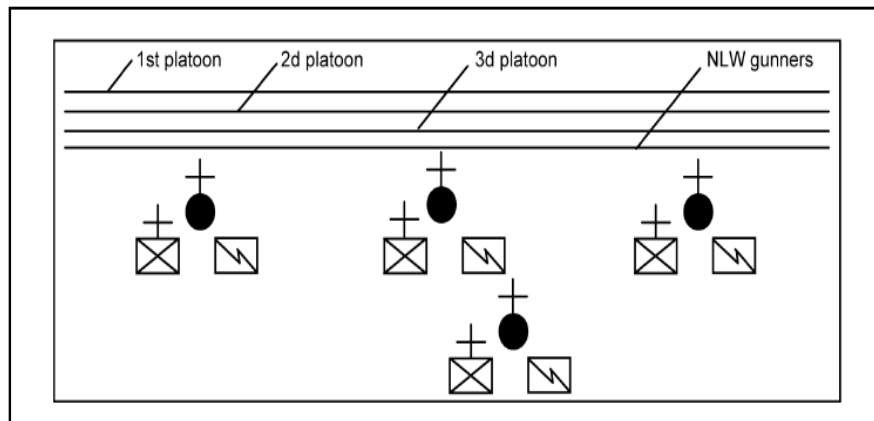

FIGURE 3-41. Company Line in Mass Formation

5. Company Line with Support. In company formations, the 1st platoon usually forms the lead element and the 2d and 3d platoons provide support (see Figures 3-42, 3-43, and 3-44). The support platoons can be employed in the same manner as the support squads in platoon formations. One platoon can be relieved from the lead element by another platoon while in formation by having a support platoon pass through the lead platoon.

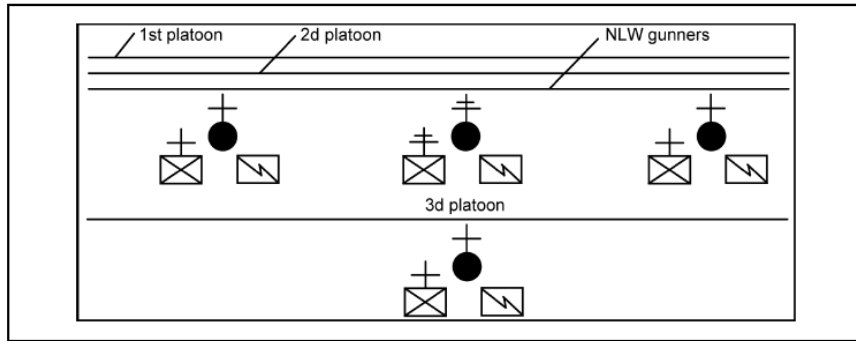

FIGURE 3-42. Company Line in Mass Formation with One Platoon in Depth

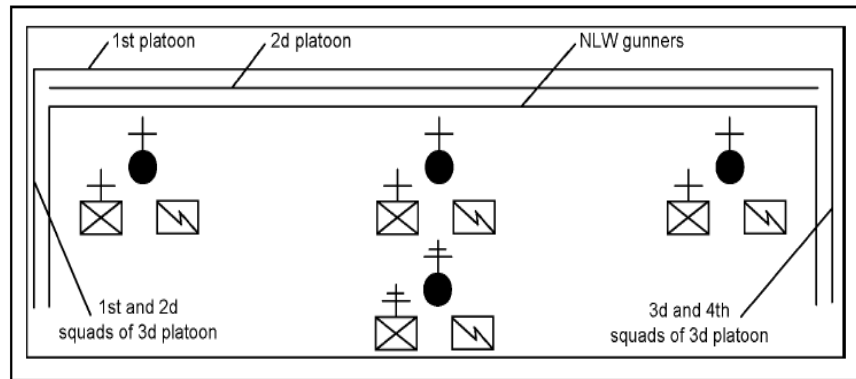

FIGURE 3-43. Company Line in Mass Formation with One Platoon in Lateral Support.

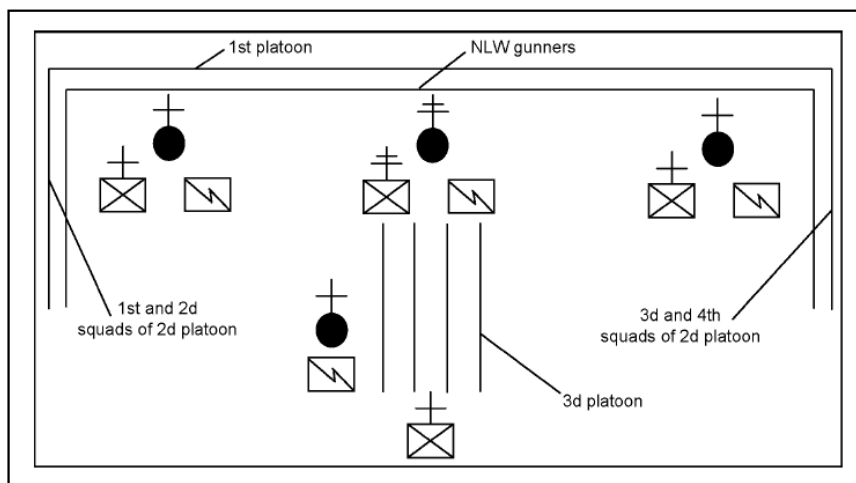

FIGURE 3-44. Company Line, One Platoon in Lateral Support and One Platoon in General Support.

6. Company Echelon and Wedge Formations. The company echelon (right or left) and company wedge are formed in the same manner and with the same variations as the company line (see Figures 3-45 through 3-52).

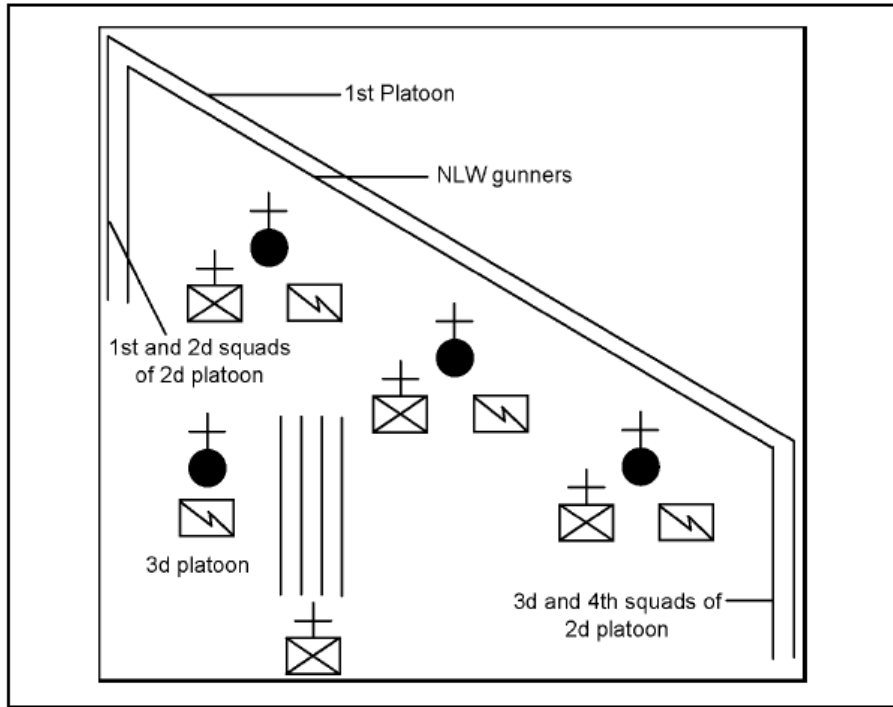

FIGURE 3-45. Company Echelon Right Formation with One Platoon in Lateral support and One Platoon in General support.

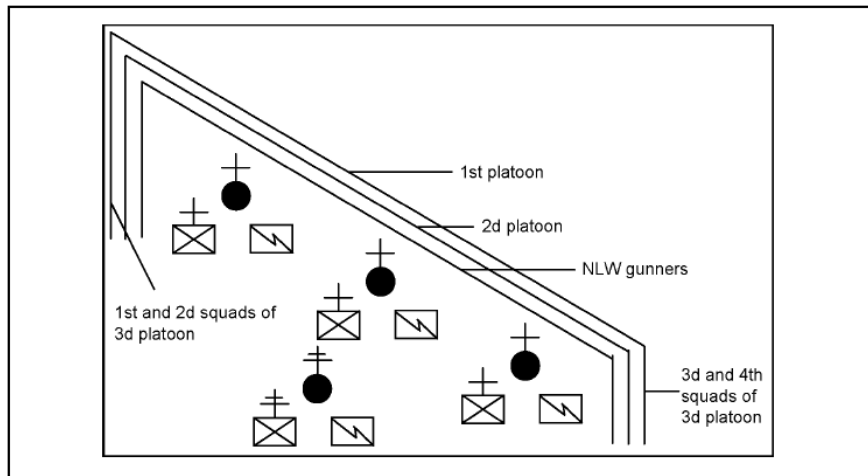

FIGURE 3-45. Company Echelon Right in Mass Formation with One Platoon in lateral Support and One Platoon in General Support.

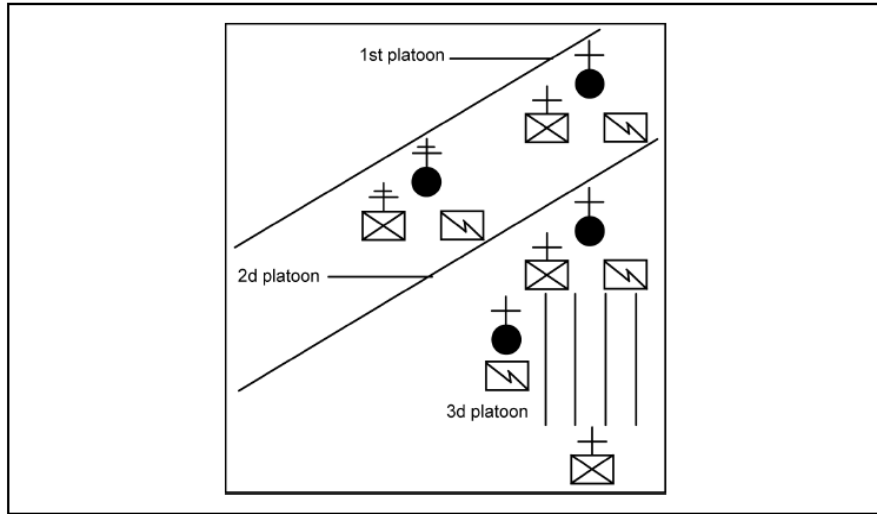

Figure 3-46. Company Echelon Right in Mass Formation with One Platoon in Lateral Support.

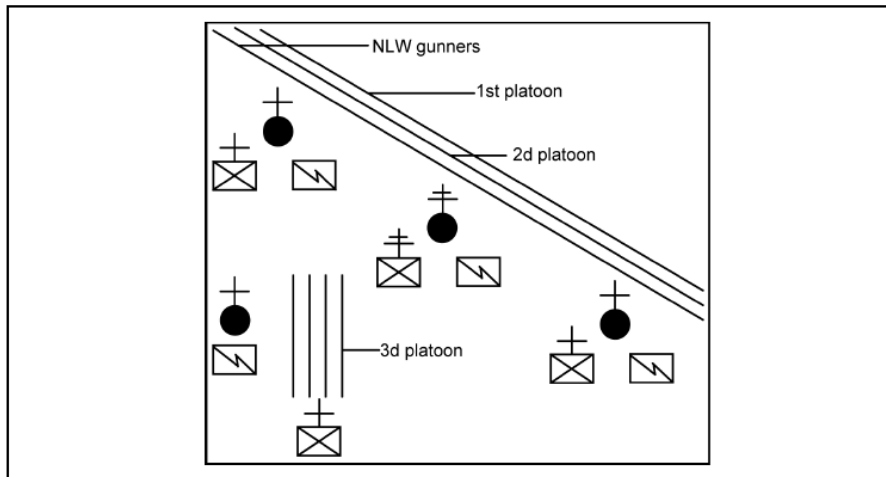

FIGURE 3-47. Company Echelon Right in Mass Formation With One Platoon in General Support.

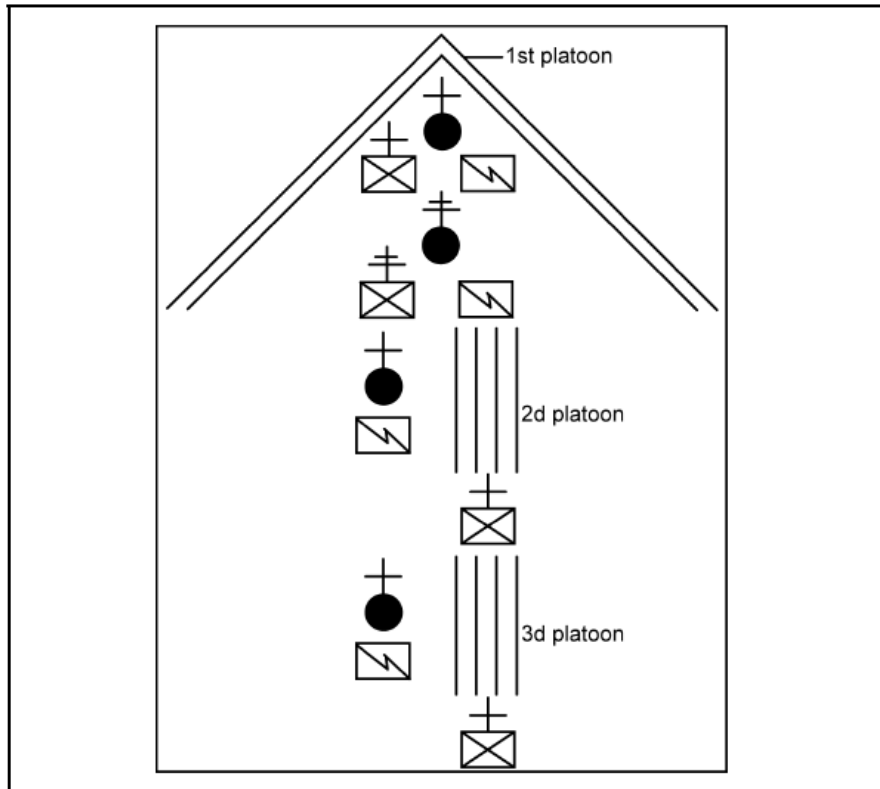

FIGURE 3-48. Company Wedge Formation with Two Platoons in General Support.

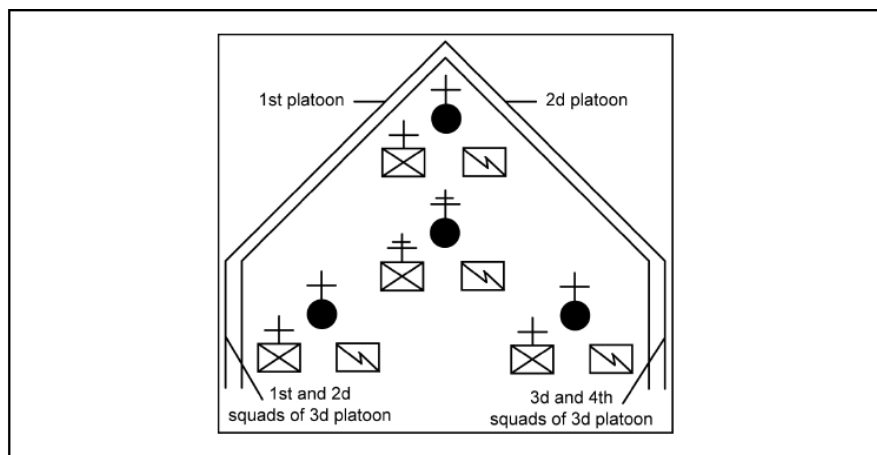

FIGURE 3-49. Company wedge Formation with One Platoon in Lateral Support.

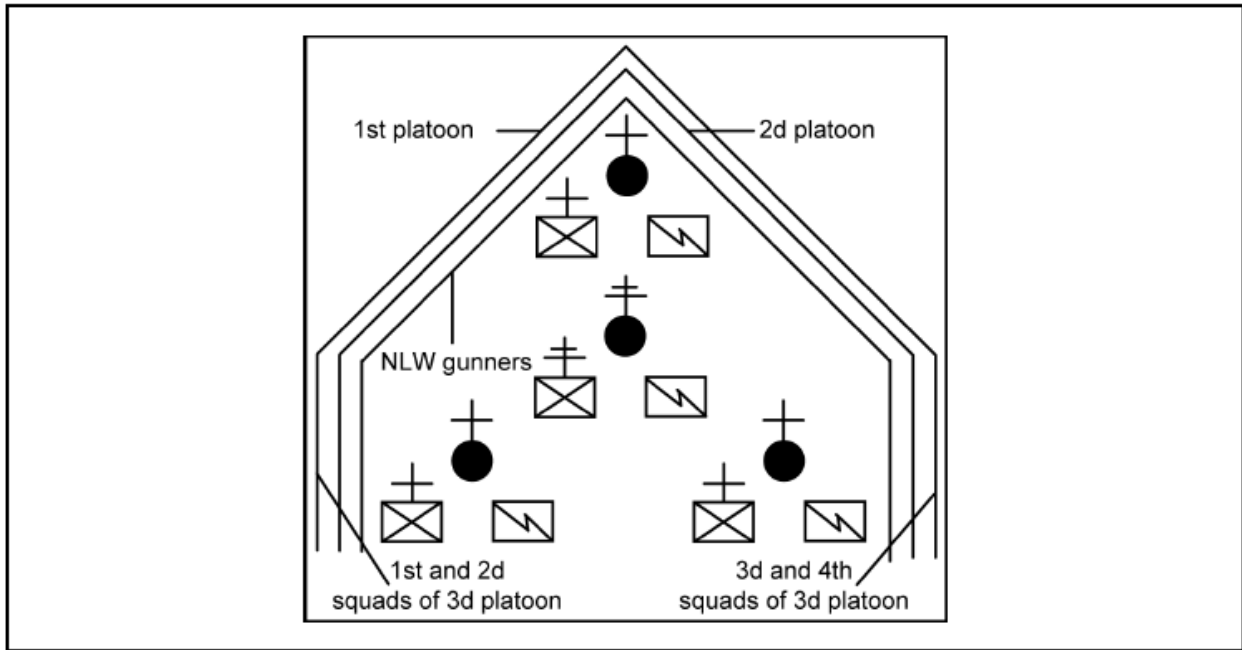

FIGURE 3-50. Company Wedge Formation with One Platoon in Lateral Support and One Platoon in General Support.

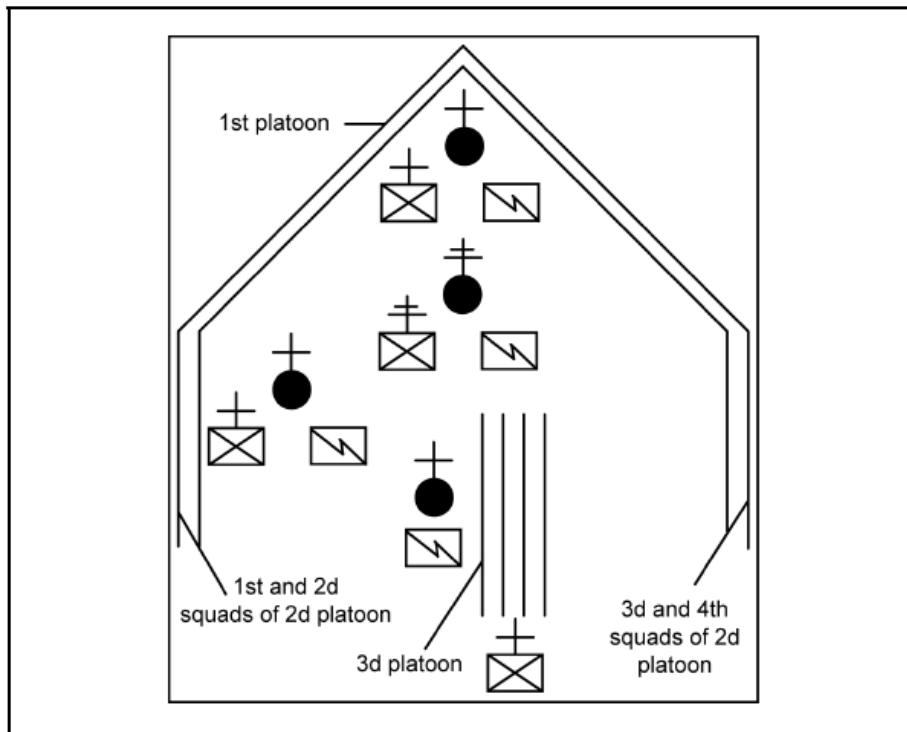

FIGURE 3-51. Company Wedge Formation With One Platoon in Lateral Support and One Platoon in General Support

7. Assembling a Company. A company assembles from a crowd control formation in the same manner as a platoon or a squad does. However, due to the size of company formations, the commander must consider the area that the company is operating in when he assembles the company. If he follows the guidelines of platoon assembly, he will have no difficulty. When assembling the company, the commander takes a position to the rear of the formation and commands, "Company Assemble." The platoon leaders take charge of their respective platoons. Usually, the 3d platoon assembles first, just behind the formation. After the 3d platoon is assembled,



the 2d platoon assembles in front of the 3d platoon and the 1st platoon assembles in front of the 2d. All platoons assemble facing the commander. The 2d and 3d platoons then dress with the 1st platoon. As each platoon is assembled, they are ordered to port arms by the platoon leader to await further orders from the commander. If four platoons are used, the 4th platoon assembles first.

## 8. Company and Platoon Formations With Vehicles..

a. When encountering large riotous groups, it may be helpful to use vehicles with foot Soldiers in crowd control formations. While vehicles add strength to formations, certain safeguard measures should be taken.

(1) Windshields of vehicles may be in upright positions, removed, or completely depressed. If windshields are of safety glass, they offer some protection in an upright position to front seat occupants with minimum danger of injury from glass fragments.

(2) Shields or mobile barriers may be constructed by mounting a wooden or metal frame strung with barbed wire across the front of a vehicle.

(3) Foot Soldiers in formation should walk as near the front corners of each vehicle as possible to prevent rioters from attacking the sides or rear of the vehicles.

b. Armored vehicles should be used when available and practicable because of their psychological effect and the protection they afford their occupants.

(1) Vehicles should be used only in conjunction with foot Soldiers.

(2) Whenever vehicles and foot Soldiers are used, the commander of the foot Soldiers commands the unit. He joins the leader of the motor section in the command (number 1) vehicle where he has a position of vantage (see Figure 3-51). In every instance, his commands are carried out through the subordinate leaders

(3) If possible, headquarters personnel should travel with the commander.

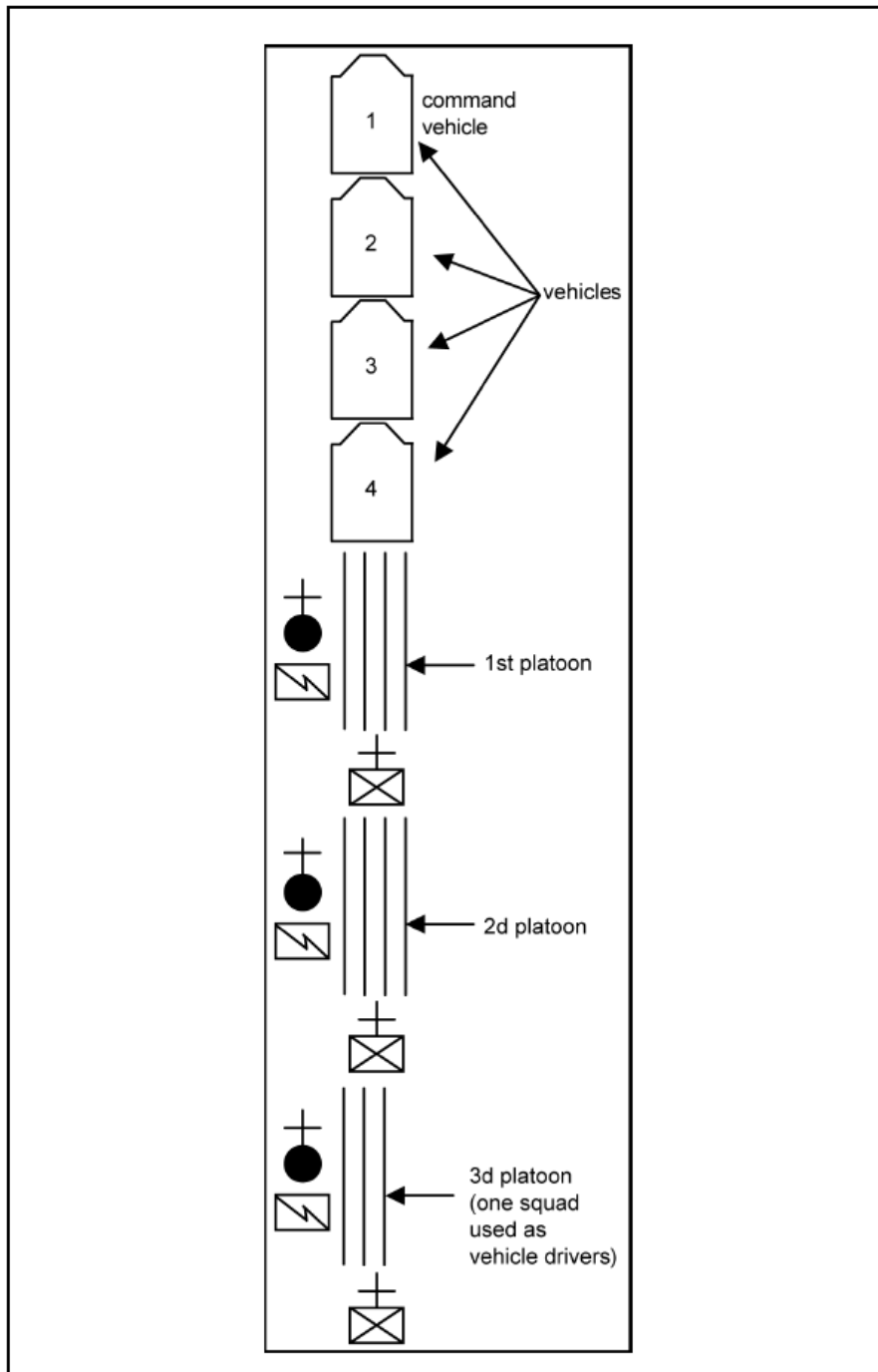

FIGURE 3-51. Position for Foot Soldiers and Vehicles Prior to Carrying out Crowd Control Formations.

c. Company Line with Support.

(1) Command. The commands for vehicles and foot Soldiers are the same as foot Soldiers alone. Because of the additional noise and distances involved, the company commander gives the arm and hand signal for the line. The command and signal apply to the lead platoon only. The other platoons remain in general support until directed further.

(2) Execution. The motor section moves out with vehicle number two moving to the right. Vehicle number two passes the lead vehicle and establishes the position for the center of the line. At the same

time, the 3d and 4th vehicles swing out to the left and right. They form to the left and right and slightly to the rear of vehicle number two. The 1st and 4th squads of the lead platoon then move forward and form lines to the left and right, on the front end of vehicle number two. As soon as the troops are in position, the 3d and 4th vehicles close in on the squads and tighten the formation. The 2d and 3d squads of the lead platoon then form a line to the left and right of the 3d and 4th vehicles to complete the company line. The command vehicle (vehicle number one) takes up a position behind the line where the commander can direct and control the unit. The 2d and 3d platoons move forward and are used in general, lateral, or direct support. In some instances, foot troops move into position first and vehicles join the formation, as needed. (see Figures 3-52, 3-53, 3-54, 3-55, 3-56, 3-57, and 3-58 for types of vehicles formations)

9. Echelon or Wedge. To form a company echelon or a company wedge with vehicles, the company follows the same procedures used for company formations without vehicles. Vehicles are moved into the appropriate positions using procedures similar to those used for a company line.

10. Assembling Foot Soldiers and Vehicles. To assemble troops and vehicles, the command vehicle moves to a position behind the formation. The commander faces the formation and gives the vehicle section the signal for assembly. Immediately, the vehicles return to their proper positions in column formation behind the command vehicle while the troops stand fast.

11. Variations of Formations. Many suitable variations to the formations described and illustrated above may be used, and appropriate commands and signals may be devised to carry them out. Because of the somewhat complicated nature and coordination required in these formations, however, new variations should be practiced extensively before they are used in actual riot situations.

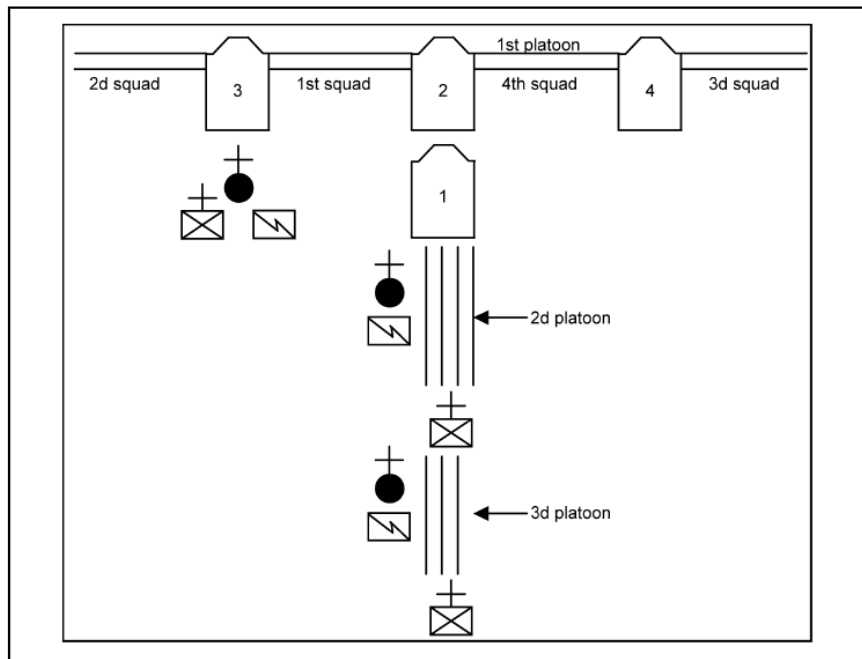

FIGURE 3-52. Company Line Formation With Vehicles and Two Platoons in General Support.

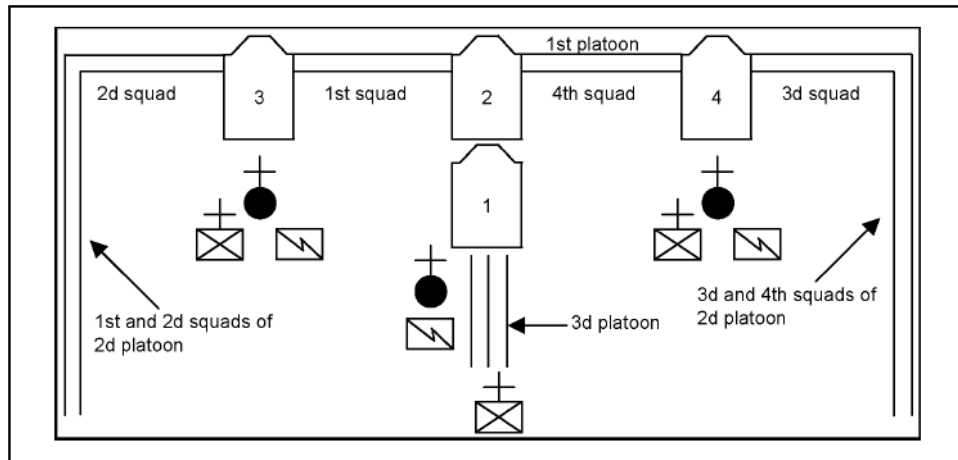

FIGURE 3-53. Company Line Formation with Vehicles, One Platoon in Lateral Support, and One Platoon in General Support.

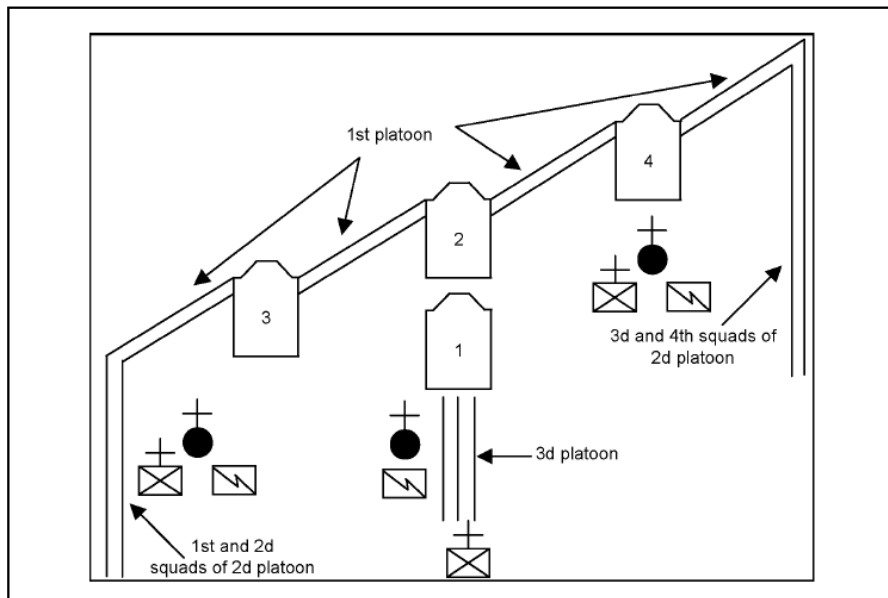

FIGURE 3-54. Company Echelon Right Formation with Vehicles, One Platoon in Lateral Support, and Platoon in General Support.

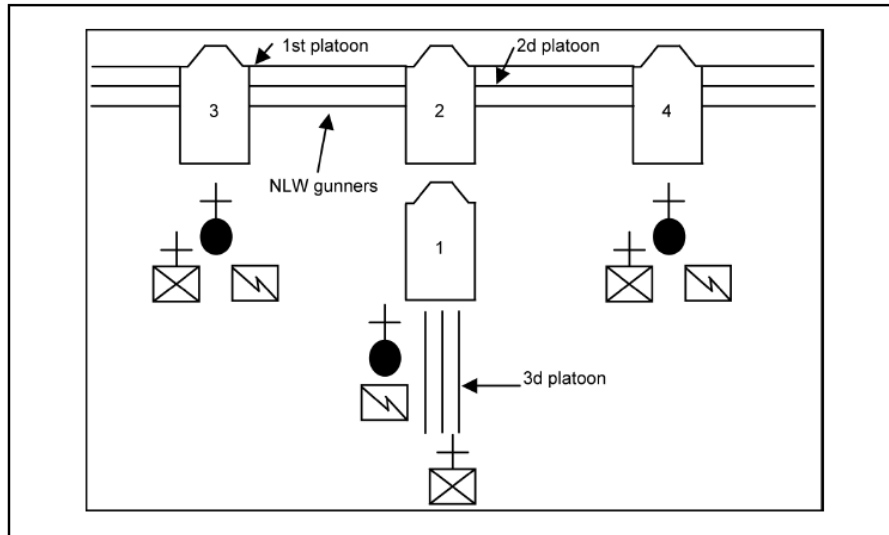

FIGURE 3-55. Company Line in Mass Formation with Vehicles and One Platoon in General Support.

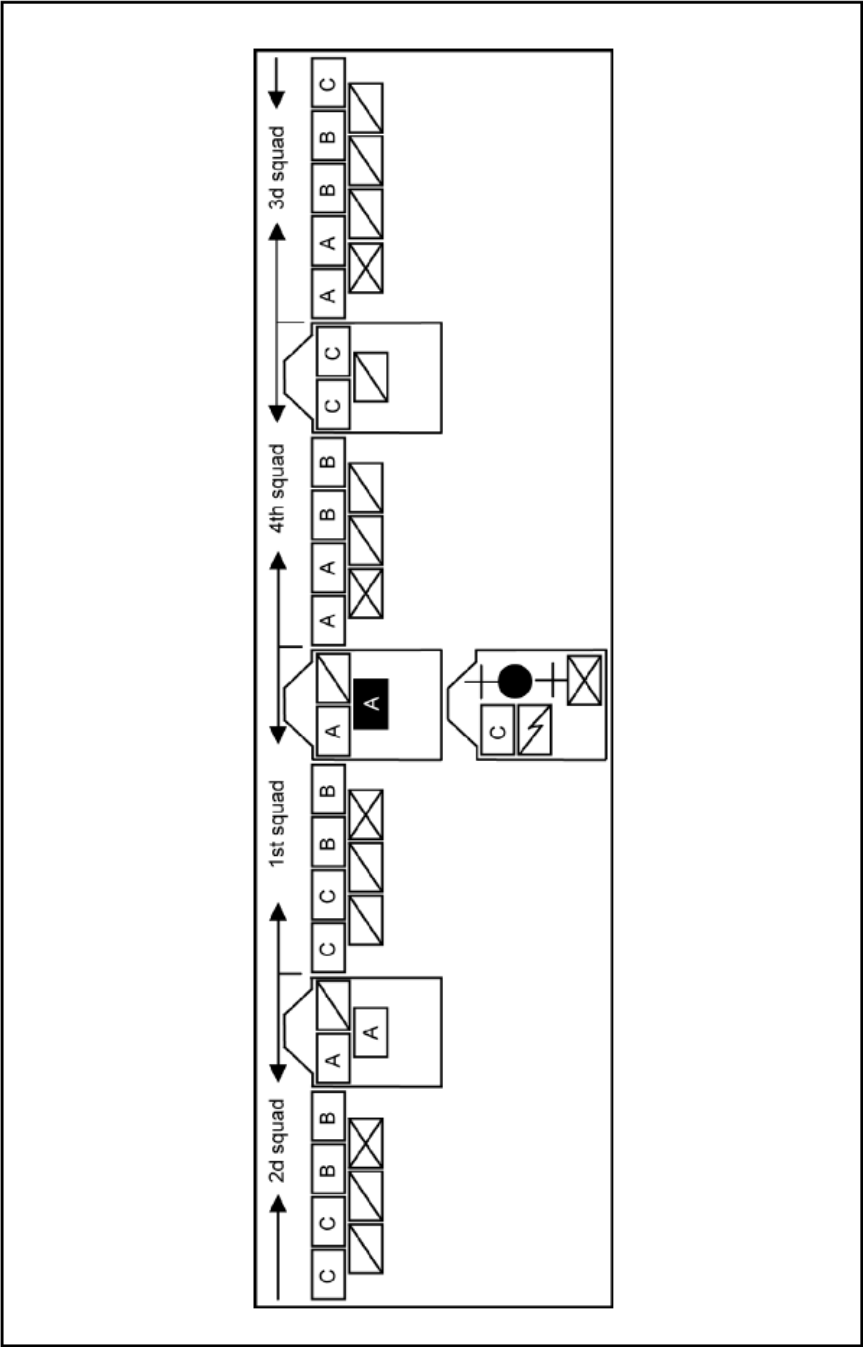

FIGURE 3-56. Platoon Line Formation with Vehicles.

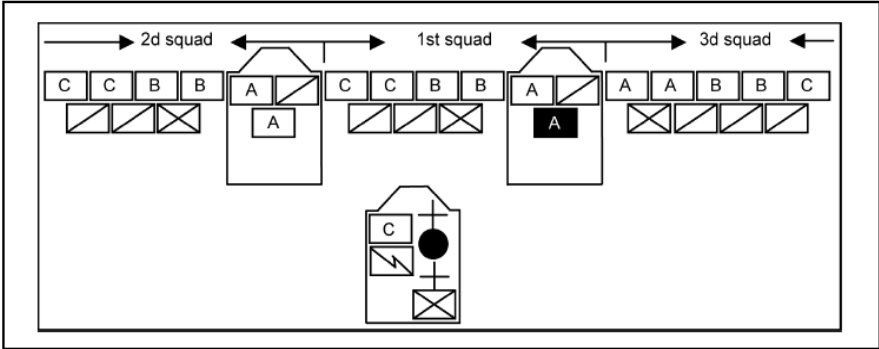

FIGURE 3-57. Platoon Line Formation with Direct Support and Vehicles.

## SUMMARY

During the course of this lesson you have learned that that through the studies of the histories of war that success in battle is not always determined by the number of Soldiers or firepower. Success is more often determined by the discipline and training of the Soldiers involved. This situation often applies to civil disturbance control operations because our Soldiers can be expected to be greatly outnumbered. You have been taught that through a system of crowd control formations that the numbers concerning the control force and the demonstrators can be offset. By implementing and training what you have learned, you will continue to gather more knowledge of these crowd control formations to assist you in effectively employing your Soldiers in a civil disturbance operation.

### Lesson 3 Practice exercise)

The following questions are multiple choice and/or true/false. You are to select the one that is correct. Show your choice by CIRCLING the letter beside the correct choice directly on the page. This is a self-graded lesson exercise. Do not look up the correct answer from the lesson solution sheet until you have finished. To do so will endanger your ability to learn this material. Also, your final examination score will tend to be lower than if you had not followed this recommendation.

1. The normal cadence for movement into and assembly from all crowd control formation is
  - A. Route step.
  - B. Quick time.
  - C. Double time.
  - D. Any of the above.
1. After breaking up a large crowd with crowd control formations
  - A. The control force should stand in place.
  - B. The control force is normally relieved of duty.
  - C. As many arrests as possible should be made.
  - D. Small groups of rioters may form.
1. A formation used in order to apprehend a person surrounded by a crowd is the
  - A. Line.
  - B. Echelon left.
  - C. Diamond.
  - D. Wedge.
1. Vehicles should always be used.
  - A. With foot Soldiers.
  - B. As a last resort.
  - C. In mass.

D. In pairs.

1. The following arm signal is for a.



- A. Line formation.
- B. Wedge formation.
- C. Echelon formation.
- D. Squad in support formation.

1. The safe port position is

- A. Extremely useful for a show of force.
- B. Not useful because it cannot be seen at the rear of the crowd.
- C. Used only to move away from crowd formations.
- D. Easy to maintain over extended periods of time.

1. The best formation to hold back a threatening crowd is the

- A. Echelon.
- B. Diamond.
- C. Wedge.
- D. Line

1. When getting ready to use crowd control formations, it is best to

- A. Assemble in full view of the crowd, but at a safe distance.
- B. Form the desired formation and double time toward the crowd.
- C. March in column formation to a safe distance from the crowd.
- D. Use crowd control agents prior to assembly.

1. The command used to form a squad into a line formation is

- A. Extend to the right, Move.
- B. Fall in on line, Move.
- C. Squad Line Formation, Move."
- D. Squad as skirmishers, Move.

1. When in column, the commander at each echelon normally assumes his position

- A. At the front of the column.
- B. To the right of the column.
- C. To the left of the column.



D. At the rear of the column.

1. The hand signal for a line is



A

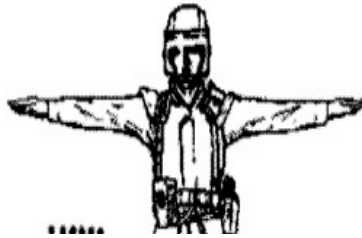

B



C



D

1. In any echelon formation with normal interval and distance, the angle made by the formation and the route of advance will be approximately \_\_\_\_\_.

- A. 30 degrees.
- B. 35 degrees.
- C. 40 degrees.
- D. 45 degrees.

1. What are the two base element ranks?

- A. Shield holders, and nonlethal weapons.
- B. Shield holders and baton holders.
- C. Extraction and apprehension teams.
- D. Riot control agent dispenser operations and squad leaders.

### LESSON 3

#### PRACTICE EXERCISE

#### ANSWER KEY AND FEEDBACK

Item

Correct Answer and Feedback

1. C. Double time. (page 3-15)

2. D. Small groups of rioters may form. (page 3-4)
3. C. Diamond.  
When Soldiers penetrate. (page 3-6)
4. A. With foot Soldiers. (page 3-5)
5. B. Wedge formation. (page 3-14)
6. A. Extremely useful for a show of force. (page 3-10)
7. D. Line. (page 3-6)
8. C. March in a column formation to a safe. (page 3-7)
9. C. Squad Line Formation, Move." (page 3-17)
10. A. At the front of the column.  
When in a... (page 3-11, para 3a)
11. B. Figure 3-3 (page 3-14)
12. D. 45 degrees (page 3-16)
13. A. Shield holders and NLW (page 3-6)

## LESSON 4

### RIOT CONTROL AGENT DISPERSER

#### OVERVIEW

##### LESSON DESCRIPTION:

This sub-course is designed to describe how agents are dispersed and required equipment maintenance.

##### TERMINAL LEARNING OBJECTIVE:

**ACTION:** Maintain and operate riot control agent dispersers.

**CONDITION:** You will have this subcourse.

**STANDARD:** To demonstrate competency of this task, you must achieve a minimum score of 70 percent on the final subcourse examination.

**REFERENCES:** The material contained in this lesson was derived from the following publications: FM 3-

## INTRODUCTION

Crowd control agents provide us a distinct advantage in controlling civil disturbances and give us a humane and effective method of dispersing dissidents. Crowd control agents have many advantages over other types of force. They have an immediate effect on large groups of people without causing any permanent harm. When conditions are favorable, these agents, properly used, will disperse large mobs without the control forces actually making contact with the dissidents. To properly use crowd control agents, it is vital that you have a thorough understanding of their capabilities, potential hazards, and methods of use. You must also be able to properly operate the special items of equipment needed to disperse crowd control agents during a confrontation.

### 1. Crowd Control Agents.

a. CS. This agent is the current standard crowd control agent. Its application produces an extreme burning sensation of the eyes, an abundant flow of tears, an involuntary closing of the eyes, a stinging sensation on moist areas of the body, and other discomforting physiological symptoms. It may cause nausea and mild vomiting if received in heavy concentrations (such as within a closed room), but no permanent injury will result from the use of CS.

**WARNING: BE AWARE THAT FIRES MAY START WHEN USING CS. REFER TO FM 4-30.13, AMMUNITION HANDBOOK FOR SPECIFIC INFORMATION.**

b. OC. More widely known as "Pepper Spray", OC is made completely from organic materials and is FDA-approved for sale over-the-counter in the United States. It causes severe and immediate burning sensation to mucous membranes when sprayed into face, nose, and eyes.

### 2. Methods of Disseminating Crowd Control Agents.

a. Individual Riot Control Agent dispenser (M36). The M36 (see Figure 4-1) contains a Dibenz (F, -1 4-oxazepine [CR] solution). It can deliver 25 one-second bursts out to 12 feet. Individual disposable RCA dispensers are intended primarily for self-defense or to keep rioters out of arm's reach of Soldiers conducting crowd control formations or Soldiers engaged in missions where a noncombatant exists.



FIGURE 4-1. Individual Riot Control Agent Dispenser (M36).

b. Midsize Riot Control Agent Dispenser (M37). The M37 (see Figure 4-2) is the size of a standard fire extinguisher that uses compressed air to force the RCA out to a range of 30 feet. It has the capacity to employ 18 bursts for 3 seconds per charge. It is excellent for providing a wide coverage of RCAs onto a hostile crowd while maintaining excellent standoff capability. The M37 can be refilled and is rechargeable. It can be filled with CR solution (liquid agent) or CS1 (dry agent). For training purposes, CR can be substituted with water and CS1 can be substituted with talcum powder.



FIGURE 4-2. Midsize Riot Control Agent Dispenser (M37).

c. Squad Riot Control Agent Dispenser (M33A1). The M33A1 (see Figure 4-3) is designed to provide crowd control and protection at the squad level. It is capable of projecting a ballistic stream of RCAs beyond 25 feet in up to 25 half-second bursts. It consists of a frame and harness assembly, compressed-gas cylinder (agent container assembly), air pressure assembly, gun and hose assembly, multijet spray unit, and check valve assembly. The M33A1 can be refilled and is



FIGURE 4-3. Squad Riot Control Agent Dispenser (M33A1).

d. M7 66-Millimeter Launcher with M315 Installation Kit. The M7 (see Figure 4-4) is a 66-millimeter vehicle-mounted, NL, grenade-launching device that is mounted on a HMMWV. It is an indirect fire support system that can deliver the M98 distraction grenade that creates a flash-bang effect, L96A1 antiriot grenade, or M99 blunt trauma grenade that creates a sting-ball effect. The M315 installation kit is used to install an M7 discharger on the turret ring of appropriate HMMWV variants. An adjustable bracket allows the launch angle

to be depressed for engaging targets at ranges of 50, 75, and 100 meters. The system enforces standoff distances and deters potential threats.



FIGURE 4-4. M7 66-Millimeter Launcher with M315 Installation Kit.

e. L96A1, Grenade, Discharger, Antiriot Grenade. The L96A1 (see Figure 4-5) is a 66 millimeter projectile that contains 23 canisters filled with CS compound. At a muzzle velocity of 35.8 meters per second (117.5 feet) the projectile has a deployment range of 65 to 95 meters. The antiriot (CS) is released from the submunitions as they burn on the ground.



FIGURE 4-5. L96A1, Grenade, Discharger, Antiriot Grenade

f. M203 grenade launcher. Using the CS round for the M203 grenade launcher, CS agent can be accurately used against a point target at a range of 200-400 meters. Caution should be used not to fire the round directly at a person as injury from the projectile as possible. The M47 CS round may also be hand dispersed at a less effective range.

### 3. Principal Factors that will Govern the Employment of Crowd Control Agents.

a. To determine whether crowd control agents may be used effectively and how they can best be dispersed, many factors must be considered.

- (1) Effect of weather and terrain. After the crowd control agent has been released into the atmosphere, the agent cloud will rise and drift downwind in a manner entirely dependent upon existing weather and terrain.
- (2) Vertical rise. Agent clouds, which are a suspension of particles in the air, are initially warmer than air and tend to rise rapidly. As these particles cool, they will subsequently settle back to earth.
- (3) Lateral spread. Agent clouds will be blown from side to side by shifting air currents. As a general rule, lateral spread is equal to about 15 to 20 percent of the distance traveled.
- (4) Obstacles. Agent clouds will be disrupted by terrain obstacles, such as trees and buildings, and their effectiveness reduced. As a general rule, an obstacle will disrupt an agent cloud for a downwind distance of 30 times the height of the obstacle.
- (5) Favorable conditions. The downwind travel of agent clouds will be favorably affected by the conditions listed below. The reverse of these conditions will, of course, adversely influence the performance of the agent cloud.
  - (a) Steady wind direction.
  - (b) Moderate wind velocity (less than 10 mph).
  - (c) High relative humidity.
  - (d) Ground temperature colder than air temperature.
  - (e) Minimal obstacles, such as open areas, little vegetation, and no buildings.

b. Operational Objective. The manner of using crowd control agents will vary with the operational objective being pursued. By varying the amount and method of use, different effects can be produced on the crowd or mob.

- (1) Dispersal. The most common usage of crowd control agents is to motivate hostile crowds to leave the area. CS, applied in sufficient quantities by either grenades or dispersers, is usually highly effective. Caution must be used and escape routes must be made available.
- (2) Splitting a Crowd. When it becomes necessary to split a crowd, CS may be applied so as to produce a narrow cloud through the center of the crowd. This will split the crowd for the duration of the agent cloud's effectiveness.
- (3) Deny Access to Area. When conditions warrant, access to an area may be denied by applying micro-pulverized CS. The persistency of the agent, when mixed with the surrounding earth, vegetation, or other material, will discourage the approach of unprotected personnel for the period of the agent's effectiveness.
- (4) Anti-barricade Operations. Where persons, such as snipers or other armed and dangerous persons, are barricaded within buildings, crowd control agents may be invaluable in effecting their apprehension with minimum danger to the control force and bystanders. When arrest teams are in position, M47 grenades may be applied, first in the surrounding area, then within the barricaded room itself.

c. Motivation of Dissidents. A thorough application of CS should be sufficient to convince most persons to cease their disorderly conduct. However, riots or demonstrations have involved rioter or demonstrators that

are young, healthy, and most importantly, highly motivated. Such demonstrators have frequently been able to withstand repeated dosages of crowd control agents, withdrawing from the agent cloud and returning once the cloud dissipates. In such cases, application of crowd control agents alone is obviously not sufficient to subdue the disorder; they must be followed by other measures such as selective or mass arrests.

#### 4. Training.

a. Training of Soldiers for use of crowd control agents should include, but not be limited to, the following:

(1) Individual Training.

- (a) Policy on the employment of crowd control agents.
- (b) Characteristics of crowd control agents.
- (c) Individual protection, first aid, and decontamination.
- (d) Maintenance of crowd control agent munitions and equipment.

b. Unit Training.

- (1) Crowd control agent squad organization.
- (2) Tactical employment of crowd control agents in crowd control.

#### 5. Operation and Employment of Crowd Control Agent Dispersers.

a. General. The following provides data and guidance for commanders, staff officers, and all personnel concerned with the utilization of crowd control agent dispersers in the control and suppression of disorders. It covers concepts and techniques for use of the crowd control agent dispersers and provides guidance for the training of operating personnel.

b. Concept of Employment. The crowd control agent dispersers were developed to provide commanders with a capability for distributing crowd control agents in sufficient quantities to provide effective area coverage under a variety of situations and weather conditions. They are not designed for the direct introduction of a crowd control agent into barricaded buildings. Care must also be exercised in their use in confined areas and against target areas with restricted avenues of escape. Normal usage envisions transport of these dispersers by persons, by 1/4-ton or larger vehicles, or by helicopters. When transported by the ground, by individual or by vehicle, the dispersers may be directly integrated into crowd control troop formations or may be operated from a position in direct support of confrontation control operations. Dispersers mounted in helicopters are used in close conjunction with the control Soldiers and in direct implementation of the immediate plan of operations. The exact location of the aircraft, with respect to troop formation, at the time of release of crowd control agents will be determined by current wind direction and speed, and in some instances by such physical obstacles as may place a restriction on the movements or positioning of the aircraft.

c. Personnel.

- (1) Although it is desirable that all unit personnel should have knowledge of the operation and employment capabilities of the crowd control agent dispersers, main reliance in this respect must be



placed on specially selected and trained persons. Such personnel should be chosen for initiative, ability to learn, and proven calmness when faced with large numbers of agitated people.

(2) Persons named as disperser operators and/or as team members should be well-qualified in their primary MOS as members of the military police or other units authorized as dispersers, and thoroughly trained in civil disturbance operations. Preferably they should have received special training in the use of crowd control agents.

d. To ensure equipment is operational when it is needed, preventive maintenance and service must be performed.

#### 6. Authority and Limitations on the Use of Crowd Control Agents.

a. Experience and common sense have dictated some rules for the effective use of crowd control agents. These rules, while not absolute, should be duly considered before using crowd control agents.

##### (1) Limitations.

(a) Do not use around hospitals or other places where innocent persons may be affected.

(b) Do not use around highways where drivers may be affected.

(c) Do not use where fires may start or asphyxiation may occur.

(d) Do not use where control forces may be unprepared and adversely affected.

(e) Do not use prior to coordinating with all agencies in the affected area.

(f) Do not use where a change in wind would cause harm or hamper control operations.

(g) Do not use where inadequate quantities of agents are available and its use would be indecisive yet increase hostilities.

(h) Do not expose crowd control dispersers to the crowd without adequate protection of accompanying control forces.

b. Authority to Use Crowd Control Agents. The criteria for authority to use crowd control agents will vary between police agencies. For crowd control agents to be used effectively agents must be readily available and the control force must have the authority to use them

## SUMMARY

During the course of this lesson you have learned that crowd control agents provide a distinct advantage in controlling civil disturbances and give us a humane and effective method of dispersing dissidents. We also covered the proper way to mount the dispenser on your person, firing the dispenser, clearing stoppages as well as the limitations of the dispenser.

### Lesson 4 – Practice exercise

The following questions are multiple choices and/or true/false. You are to select the one that is correct. Show your choice by CIRCLING the letter beside the correct choice directly up the page. This is a self-graded lesson exercise. Do not look up the correct answer from the lesson solution sheet until you have finished. To do so will endanger your ability to learn this material. Also, your final examination score will tend to be lower than if you had not followed this recommendation.

1. The use of crowd control agents in anti-barricade operations is preferred because:
  - A. It causes minimum danger to the control force and bystanders.
  - B. No other type of force is authorized against barricaded personnel.
  - C. It is effective in splitting a crowd outside the barricade.
  - D. The lateral spread of the agent reaches its maximum effect at the barricade.
  
2. Which of the following statements is INCORRECT concerning CS?
  - A. It may cause nausea and vomiting.
  - B. It causes an extreme burning sensation in the eyes.
  - C. It causes a stinging sensation on moist areas of the body.
  - D. It causes a voluntary closing of the eyes.
  
3. Which of the following is the current standard crowd control agent?
  - A. OC.
  - B. HC.
  - C. CS.
  - D. CN.
  
1. Which atmospheric conditions are BEST for using crowd control agents?
  - A. Overcast nights, low humidity.
  - B. Moderate wind, high humidity.
  - C. Buildings around, low humidity.
  - D. Steady wind, low humidity.
  
5. Which method of disseminating crowd control agents is described as the size of a standard fire extinguisher?
  - A. Midsize Riot Control Agent Dispenser (M37)
  - B. Individual Riot Control Dispenser (M36)
  - C. Squad Riot Control Agent Dispenser (33A1)
  - D. M7 66-Millimeter Launcher
  
1. The individual training in the use of crowd control agent is limited to, Policy on the employment of crowd control, Characteristics of crowd control agents, Individual protection, first aid, and decontamination, Maintenance of crowd control agent's munitions and equipment.
  - A. True
  - B. False
  
1. Crowd control agent dispersers are NOT recommended for which of the following actions?

- A. Use in a closed area.
- B. Use around other crowd control personnel.
- C. Use in airborne dispersal.
- D. Use around highways or hospitals.

#### Lesson 4 ANSWER KEY AND FEEDBACK

Item	Correct Answer and Feedback	
1.	A.	It causes minimum danger to the control. (page 4-6)
2.	D.	It causes a voluntary closing of the eyes. (page 4-4)
3.	C.	This is the current standard crowd control agent. (page 4-4)
4.	B.	Moderate wind, high humidity. (page 4-5)
5.	A.	Midsize Riot Control Agent Dispenser (M37). (page 4-4)
6.	B.	Training of Soldiers for use of crowd control agents should include, but <b>not be</b> limited to , the following : (page 4-6)
7.	D.	Introduction to a highway or hospital areas where innocent persons may be exposed.. (page 4-7)